

KEMA TYPE TEST CERTIFICATE OF COMPLETE TYPE TESTS

Object A direct connected, electronic single-phase two-wire, keypad pre-payment two-element energy meter **1269-19**

Type DDSY283SR - active: class 1/B - reactive: class 2

Manufacturer Holley Technology Ltd.,
No.181 Wuchang Avenue, Yuhang District,
310023 HANGZHOU,
China

Production location Holley Technology Ltd.,
No.181 Wuchang Avenue, Yuhang District,
310023 HANGZHOU,
China

Tested by KEMA B.V.,
Utrechtseweg 310, Arnhem, the Netherlands

Date of tests December 2018 till May 2019

The object, constructed in accordance with the description, drawings and photographs incorporated in this Certificate, has been subjected to the series of proving tests in accordance with the complete type test requirements of

IEC 62052-11:2003, IEC 62053-21:2003, IEC 62053-23:2003, EN 50470-1:2006, EN 50470-3:2006 and IEC 62055-31:2005 including Annex A, B, C and D

The results are shown in the record of proving tests. The values obtained and the general performance are considered to comply with the above standard(s) and to justify the ratings assigned by the manufacturer as listed in chapter 3.

This Certificate consists of 90 pages in total.

KEMA B.V.



Bas Verhoeven
Director, High-Voltage
Laboratory

KEMA

Laboratories

Arnhem, 24 May 2019

INFORMATION SHEET

1 KEMA Type Test Certificate

A KEMA Type Test Certificate contains a record of a series of (type) tests carried out in accordance with a recognized standard. The object tested has fulfilled the requirements of this standard and the relevant ratings assigned by the manufacturer are endorsed by DNV GL. In addition, the object's technical drawings have been verified and the condition of the object after the tests is assessed and recorded. The Certificate contains the essential drawings and a description of the object tested. A KEMA Type Test Certificate signifies that the object meets all the requirements of the named subclauses of the standard. It can be identified by gold-embossed lettering on the cover and a gold seal on its front sheet.

The Certificate is applicable to the object tested only. DNV GL is responsible for the validity and the contents of the Certificate. The responsibility for conformity of any object having the same type references as the one tested rests with the manufacturer.

Detailed rules on types of certification are given in DNV GL's Certification procedure applicable to KEMA Laboratories.

2 KEMA Report of Performance

A KEMA Report of Performance is issued when an object has successfully completed and passed a subset (but not all) of test programs in accordance with a recognized standard. In addition, the object's technical drawings have been verified and the condition of the object after the tests is assessed and recorded. The report is applicable to the object tested only. A KEMA Report of Performance signifies that the object meets the requirements of the named subclauses of the standard. It can be identified by silver-embossed lettering on the cover and a silver seal on its front sheet.

The sentence on the front sheet of a KEMA Report of Performance will state that the tests have been carried out in accordance with The object has complied with the relevant requirements.

3 KEMA Test Report

A KEMA Test Report is issued in all other cases. Reasons for issuing a KEMA Test Report could be:

- Tests were performed according to the client's instructions.
- Tests were performed only partially according to the standard.
- No technical drawings were submitted for verification and/or no assessment of the condition of the object after the tests was performed.
- The object failed one or more of the performed tests.

The KEMA Test Report can be identified by the grey-embossed lettering on the cover and grey seal on its front sheet.

In case the number of tests, the test procedure and the test parameters are based on a recognized standard and related to the ratings assigned by the manufacturer, the following sentence will appear on the front sheet. The tests have been carried out in accordance with the client's instructions. Test procedure and test parameters were based on If the object does not pass the tests such behavior will be mentioned on the front sheet. Verification of the drawings (if submitted) and assessment of the condition after the tests is only done on client's request.

When the tests, test procedure and/or test parameters are not in accordance with a recognized standard, the front sheet will state the tests have been carried out in accordance with client's instructions.

4 Official and uncontrolled test documents

The official test documents of DNV GL are issued in bound form. Uncontrolled copies may be provided as a digital file for convenience of reproduction by the client. The copyright has to be respected at all times.

5 Accreditation of KEMA Laboratories

The KEMA Laboratories of DNV GL are accredited in accordance with ISO/IEC 17025 by the respective national accreditation bodies. KEMA Laboratories Arnhem, the Netherlands, is accredited by RvA under nos. L020, L218, K006 and K009. KEMA Laboratories Chalfont, United States, is accredited by A2LA under no. 0553.01. KEMA Laboratories Prague, the Czech Republic, is accredited by CAI as testing laboratory no. 1035. KEMA Laboratories Arnhem, the Netherlands, is also accredited by RvA in accordance with ISO/IEC 17020 under no. I049. KEMA Laboratories Arnhem, the Netherlands, is appointed as notified body with no. 2290 for 2014/32/EU Council of 26 February 2014, Measuring Instruments Directive.

TABLE OF CONTENTS

1	Summary	7
2	Introduction	8
2.1	Applied Standards	9
2.2	Subcontractors	9
2.3	Measurement uncertainty	9
3	Data related to the energy meters tested and marking	10
3.1	Current specifications	11
3.2	Accuracy class for Wh	12
4	Results of the type test	12
4.1	Tests of the mechanical properties	12
4.1.1	General	12
4.1.2	Case	12
4.1.3	Spring Hammer test	12
4.1.4	Shock test	12
4.1.5	Vibration test	12
4.1.6	Protection against penetration of dust and water	13
4.1.7	Terminals and terminal block	13
4.1.8	Resistance to heat and fire	13
4.1.9	Register and output device	14
4.1.10	Token carrier acceptor	14
4.2	Tests of climatic influences	15
4.2.1	General	15
4.2.2	Dry heat test - Storage and transport	15
4.2.3	Cold test	15
4.2.4	Damp heat cyclic test	15
4.2.5	Solar radiation test	15
4.2.6	Crystal-controlled clocks on operation reserve	16
4.2.7	Crystal-controlled clocks on a.c. supplies	16
4.2.8	Accuracy of crystal-controlled clocks at temperature limits	16
4.3	Accuracy measurement at different loads	17
4.3.1	Interpretation of test results	17
4.3.2	Test of meter constant	17
4.3.3	Starting current	17
4.3.4	Test of no load condition	17
4.3.5	Accuracy measurement at different loads in the Neutral wire	18
4.4	Effect of change of influence quantities on accuracy	19
4.4.1	Influence of ambient temperature variation	19
4.4.2	Effect of changes in the auxiliary supply voltage	21

4.4.3	Voltage variation	21
4.4.4	Frequency variation	22
4.4.5	Magnetic induction of external origin 0,5 mT	22
4.4.6	Harmonic components in the current and voltage circuits	22
4.4.7	DC and even harmonics in the a.c. current circuit	23
4.4.8	Odd harmonics in the a.c. current circuit	23
4.4.9	Sub-harmonics in the a.c. current circuit	23
4.4.10	Reversed phase sequence	23
4.4.11	Voltage unbalance	23
4.4.12	Continuous magnetic induction of external origin	24
4.4.13	Operation of accessories	24
4.4.14	Extended Voltage operation range	24
4.4.15	Abnormal voltage conditions	24
4.4.16	3 th Harmonic component in the voltage circuits	25
4.4.17	Limit Voltage range of operation with voltage.	25
4.4.18	Core functional tests within the voltage and temperature range limits	26
4.5	Effect of short time over currents on the accuracy	27
4.6	Self-heating	27
4.6.1	Influence of self-heating on the accuracy	27
4.6.2	Heating	27
4.7	Power consumption of the voltage and current circuits	28
4.7.1	According: IEC 62053-21 (measured at nominal current)	28
4.7.2	According to: IEC 62055-31 (measured at I_{max}).	28
4.8	Fast transient burst test	29
4.8.1	Test method	29
4.8.2	Test levels	29
4.8.3	Test results	29
4.9	Electrostatic discharges	30
4.9.1	Test method	30
4.9.2	Test levels	30
4.9.3	Test results	30
4.10	Immunity to electromagnetic RF fields	31
4.10.1	Test method	31
4.10.2	Test levels	31
4.10.3	Test results	31
4.11	Immunity to conducted disturbances induced by RF fields	32
4.11.1	Test method	32
4.11.2	Test levels	32
4.11.3	Test results	32
4.12	Radio interference measurement	33
4.12.1	Test levels	33



- 4.12.2 Test results 33
- 4.13 Voltage dips and short interruptions 34
 - 4.13.1 Test levels 34
 - 4.13.2 Test results 34
 - 4.13.3 The results according IEC 62055-31 Annex D 34
- 4.14 Surge immunity test 35
 - 4.14.1 Test method 35
 - 4.14.2 Test levels 35
 - 4.14.3 Test results 35
- 4.15 Damped oscillatory waves immunity test 35
- 4.16 Insulation 36
 - 4.16.1 Impulse voltage test 36
 - 4.16.2 A.C. voltage test 36
- 4.17 Immunity to conducted disturbances 2-150 kHz 37
 - 4.17.1 Test method 37
 - 4.17.2 Test levels 37
 - 4.17.3 Test results 37
- 5 Maximum permissible error 38
- 6 Durability and Reliability 39
- 7 Software and Protection against corruption..... 39
- 8 Token handling 40
 - 8.1 Interruptions to token acceptance 40
 - 8.2 Token acceptance 40
 - 8.3 Rejection of duplicate tokens 40
 - 8.4 Rejection of valid tokens when available credit is saturated 40
 - 8.5 Energy register roll-over 41
 - 8.6 Token carrier interface test 41
- 9 Load switch requirements..... 42
 - 9.1 Load switching capabilities 42
 - 9.2 Electrical endurance 42
 - 9.2.1 Required test values 42
 - 9.2.2 Test circuit 42
 - 9.2.3 Minimum switched current Test conditions: 43
 - 9.2.4 Power consumption 44
 - 9.2.5 Impulse voltage test 44
 - 9.2.6 A.C. voltage test 44
 - 9.3 Fault current making capacity 45
 - 9.3.1 Required test values 45



KEMA Laboratories	- 6 -	1269-19
9.3.2	Test circuit	45
9.3.3	Pre-fusing cycles	45
9.3.4	Fault current making capacity	46
9.3.5	Minimum switched current Test conditions	46
9.3.6	Power consumption	47
9.3.7	Impulse voltage test	47
9.3.8	A.C. voltage test	47
9.4	Short-circuit carrying capacity, test 1	48
9.4.1	Required test values	48
9.4.2	Test circuit	48
9.4.3	Pre-fusing cycles	48
9.4.4	Short-circuit current carrying capacity	49
9.4.5	Minimum switched current Test conditions	49
9.4.1	Power consumption	49
9.4.2	Impulse voltage test	49
9.4.3	A.C. voltage test	49
9.5	Short-circuit carrying capacity, test 2	50
9.5.1	Required test values	50
9.5.2	Test circuit	50
9.5.3	Pre-fusing cycles	50
9.5.4	Short-circuit current carrying capacity	51
9.5.5	Minimum switched current Test conditions:	51
9.5.6	Power consumption	52
9.5.7	Impulse voltage test	52
9.5.8	A.C. voltage test	52
Appendix A	Accuracy test results.....	53
Appendix B	Photographs of the meter	59
Appendix C	Cross-reference table and checklist for static meters.....	70
Appendix D	Plots	73
Appendix E	Checklist for Measuring Instrument Directive MID 2014/32/EU.....	80
Appendix F	Measurement uncertainty	90

1 SUMMARY

The energy meter as described in chapter 3, meets the requirements of:

- IEC 62052-11:2003 : Electricity metering equipment (a.c.) - General requirements, tests and test conditions - Metering equipment
- IEC 62053-21:2003 : Electricity metering equipment (a.c.) - Static meters for active energy (classes 1 and 2)
- IEC 62053-23:2003 : Electricity metering equipment (a.c.) - Static meters for reactive energy (classes 2 and 3)
- EN 50470-1:2006 : Electricity metering equipment (a.c.)-part 1: General requirements, tests and test conditions - Metering equipment (class indexes A, B and C)
- EN 50470-3:2006 : Electricity metering equipment (a.c.)-part 3: Particular requirements - Static meters for active energy (class indexes A, B and C)
- IEC 62055-31 (2005) : Particular requirements – Static payment meters for active energy (classes 1 and 2)

The scope of the type testing is carried out including IEC 62055-31 Annex A

The scope of the type testing is carried out including IEC 62055-31 Annex B

The scope of the type testing is carried out including IEC 62055-31 Annex C

The scope of the type testing is carried out including IEC 62055-31 Annex D

In addition the meter meets the following requirements

- Immunity to conducted disturbances in the frequency range 2-150 kHz (EN 61000-4-19, 2014 and CLC/TR 50579, 2012). See paragraph 4.17.
- Ambient temperature variation test -40°C up to 80°C. See paragraph 4.4.1.
- Water penetration test IPx4 instead of IPx1. See par 4.1.6
- Accuracy of the meter using the current measurement in the Neutral wire. See paragraph 4.3.5.

Requirements for indoor use.

Based on a non-recurrent examination.

2 INTRODUCTION

The type test was carried out at KEMA Laboratories, from December 2018 to May 2019, on behalf of Holley Technology Ltd., on the meter as described in chapter 3.

The energy meters were tested in respect of the following requirements:

IEC 62052-11:2003	:	Electricity metering equipment (a.c.) - General requirements, tests and test conditions - Metering equipment
IEC 62053-21:2003	:	Electricity metering equipment (a.c.) - Static meters for active energy (classes 1 and 2)
IEC 62053-23:2003	:	Electricity metering equipment (a.c.) - Static meters for reactive energy (classes 2 and 3)
EN 50470-1:2006	:	Electricity metering equipment (a.c.)-part 1: General requirements, tests and test conditions - Metering equipment (class indexes A, B and C)
EN 50470-3:2006	:	Electricity metering equipment (a.c.)-part 3: Particular requirements - Static meters for active energy (class indexes A, B and C)
IEC 62055-31 (2005)	:	Particular requirements – Static payment meters for active energy (classes 1 and 2)

The scope of the type testing is carried out including IEC 62055-31 Annex A

The scope of the type testing is carried out including IEC 62055-31 Annex B

The scope of the type testing is carried out including IEC 62055-31 Annex C

The scope of the type testing is carried out including IEC 62055-31 Annex D

In addition the meter was tested to the following requirements:

- Immunity to conducted disturbances in the frequency range 2-150 kHz (EN 61000-4-19, 2014 and CLC/TR 50579, 2012). See paragraph 4.17.
- Ambient temperature variation test -40°C up to 80°C. See paragraph 4.4.1.
- Water penetration test IPx4 instead of IPx1. See par 4.1.6
- Accuracy of the meter using the current measurement in the Neutral wire. See paragraph 4.3.5.

The meter was tested using functionality with energy measurement in both wires (L and N), as described below:

The meter starts measurement in the same phase as where it is switched off. Once the current in L or N is above specified threshold the meter will compare I_L and I_N .

If $I_N - I_L > 5\% I_L$, meter switches to I_N for measurement.

Next, if $I_L - I_N > 4\% I_N$, meter switches back to I_L measurement.

The kWh meters use the same measuring elements for both Wh- and varh-measurement. The meter calculates both from the same voltage and current measurement (with respect to the angle between the voltage and current). In many tests verification of the Wh function is therefore sufficient to cover compliance to both Wh- and varh- standards.

For all types being part of this type test the test plan of each type is determined based on a comparison of the different types. The expected impact on the result of each test is based on of the differences and similarities between the types. Based on that impact it is decided which types need to be tested on which test.

The test plan was based on these assumptions.

All tests are performed at reference voltage and reference frequency, unless mentioned otherwise. The measurements are carried out with standards that are traceable to international standards.

2.1 Applied Standards

The product standard refers to documents, in whole or in part, these documents are normatively referenced to in this product standard and these documents are indispensable for its application. For dated references, only the edition cited applies. For undated references the latest edition of the referenced document (including any amendments) applies. KEMA Laboratories will use the latest edition of the referenced documents (including any amendments) in all cases, also in the cases reference is made to dated editions.

2.2 Subcontractors

The following tests were subcontracted to DEKRA Certification B.V., Arnhem, the Netherlands:

- Radiated radio interference measurement fields (30 to 1000 MHz) in accordance with IEC 62052-11 and CISPR 22.

The laboratory is accredited by RvA under accreditation number L022.

The following tests were subcontracted to Sebert Trillingstechniek BV, Bergschenhoek, the Netherlands:

- shock test in accordance with IEC 60068-2-27
- vibration test in accordance with IEC 60068-2-6.

The laboratory is accredited by RvA under accreditation number L540.

2.3 Measurement uncertainty

A table with measurement uncertainties is enclosed in this report. Unless otherwise stated, the measurement uncertainties of the results presented in this report are as indicated in that table.

3 DATA RELATED TO THE ENERGY METERS TESTED AND MARKING

Manufacturer	:	Holley Technology Ltd.,
Contact person	:	Daisy Sun
Address	:	No.181 Wuchang Avenue, Yuhang District : 310023 HANGZHOU
Country	:	China
Production site	:	Holley Technology Ltd.,
Address	:	No.181 Wuchang Avenue, Yuhang District : 310023 HANGZHOU
Country	:	China
Instrument	:	Electronic single-phase two-wire keypad pre-payment two-element energy meter. Direct connected
Mark - Type	:	DDSY283SR
Register	:	LCD
Accuracy Class	:	Active: 1/B Reactive: 2
Measurement range	:	220 - 240V 0,25..5(100)A 50Hz active : 1000 imp./kWh reactive : 1000 imp./kvarh
Temperature range	:	-40 .. 80 °C
Use	:	Indoor
Protection Class	:	II
Utilisation category	:	UC3
Internal clock	:	Crystal controlled
Token carrier interface	:	Keypad interface
Payment type	:	kWh
Environmental class	:	M1, E1 and E2
Registry method	:	Programmable, Bi-directional method separate registers: received- and delivered energy of the whole connection is added in separate registers

Note

Production site information was copied from customer specification and not verified by KEMA Laboratories.

Sample identification:

99710292	DIN	DDSD285
99710293	DIN	DDSD285
99710295	DIN	DDSD285
99710297	DIN	DDSD285
99710298	BS	DDSY283SR
99710299	BS	DDSY283SR
99710303	BS	DDSY283SR
99710304	BS	DDSY283SR
99710305	BS	DDSY283SR
99710306	BS	DDSY283SR
99710307	BS	DDSY283SR
99710308	BS	DDSY283SR
99710309	BS	DDSY283SR
99710310	BS	DDSY283SR
99710311	BS	DDSY283SR
99710312	BS (Pre-Pay, keypath)	DDSY283SR
99710314	BS (Pre-Pay, keypath)	DDSY283SR
99710315	BS (Pre-Pay, keypath)	DDSY283SR
99710316	BS (Pre-Pay, keypath)	DDSY283SR
99710317	BS (Pre-Pay, keypath)	DDSY283SR
99710318	BS (Pre-Pay, keypath)	DDSY283SR
99710319	BS (Pre-Pay, keypath)	DDSY283SR
99710320	BS (Pre-Pay, keypath)	DDSY283SR
99710321	BS (Pre-Pay, keypath)	DDSY283SR
99710322	BS (Pre-Pay, keypath)	DDSY283SR
99710323	BS (Pre-Pay, keypath)	DDSY283SR

Photographs of the meter: See appendix B.

The meter contains all required markings.

The reference current and the reference voltage of the meter are standardised values.

3.1 Current specifications

The current values in this document are all based on the reference current. The relationships between the different terms of the current are clarified in the following table.

Current 0,25 .. 5(100)			
Current specification		Current A	Percentage of the reference current I_{ref}
Starting current	I_{st}	0,02	$\leq 0,4\%$
Minimum current	I_{min}	0,25	$\leq 5\%$
Transitional current	I_{tr}	0,5	10%
Basic current	I_b	5	100%
Maximum current	I_{max}	100	$\geq 500\%$

3.2 Accuracy class for Wh

The definition of the accuracy class indication of the meter is slightly different for the two standards mentioned in this document. Class B is comparable, but not identical to Class 1. This document covers all the requirements needed for the type test of a kWh meter according to Class 1 (IEC 62052-11) and Class B (EN 50470-1).

4 RESULTS OF THE TYPE TEST

4.1 Tests of the mechanical properties

4.1.1 General

The meter was subjected to the mechanical tests. In order to evaluate the materials used and the construction of the meter, the meters were assessed with regard to the following points.

4.1.2 Case

The meter can be sealed in such a way that the inside of the meter is only accessible after breaking the seal. See photograph appendix B.

4.1.3 Spring Hammer test

After carrying out the spring hammer test according to EN-IEC 60068-2-75 with a kinetic energy of 0,2 J, it showed that the mechanical strength of the meter case of the energy meter is adequate.

4.1.4 Shock test

This test was carried out on meter no. 99710312.

A shock test was performed according to EN-IEC 60068-2-27, with a half-sine pulse, a peak acceleration of 300 m/s² and a pulse duration of 18 ms. After this test the meter showed no damage.

4.1.5 Vibration test

This test was carried out on meter no. 99710311.

A vibration test according to EN-IEC 60068-2-6, test procedure A, was carried out on the meters in non-operating condition, frequency range from 10 Hz to 150 Hz, with a constant movement amplitude of 0,075 mm up to 60 Hz and a constant acceleration of 9,8 m/s² above 60 Hz. Per axis 10 sweep cycles were carried out. After the test the meter showed no damage.

4.1.6 Protection against penetration of dust and water

This test was carried out on meter no. 99710308 and 99710321 (dust) 99710305 and 99710320 (Water).

The test was carried out according to EN-IEC 60529, protection degree IP54 (indoor).

The meter is dustproof as required by EN 50470-1 and IEC 62052-11 (Cat. 2 according to EN-IEC 60529).

The results of the water penetration test were satisfying.

The meter meets the requirements.

4.1.7 Terminals and terminal block

The clearances and creepage distances in the terminal block are adequate.

The terminal block material was tested in accordance with ISO 75 at a temperature of 135 °C and a pressure of 1,8 MPa (method A). The worst case deflection at 135 °C was 0,00 mm (requirement $\leq 0,34$ mm). The material meets the requirements.

Specification of the material:

Type: PC+20%GF

Manufacturer: CGN

Colour: GE COLOR CHIP NO.GD4023

The terminal cover can be sealed independently of the meter cover.

4.1.8 Resistance to heat and fire

The material of both the terminal block and the meter case was subjected to a glow-wire test in accordance with EN-IEC 60695-2-10 and EN-IEC 60695-2-11. The temperature of the glow-wire was 960 °C for the terminal block, 650 °C for the meter case and cover.

The materials meet the requirements.

4.1.9 Register and output device

The meter has an LCD and records in kWhs and kvarhs.

On the front of the meter optical (LED) outputs are available for Wh- and varh measurements.

In normal operation important indicators can be programmed on the payment meter such as:

- Available kWh energy register
- Cumulative kWh energy register
- Current date
- Current time

The utilisation category are marked on the meter

The energy registry method with regards to delivered- and received energy is the Bi-directional method with separate registers: received- and delivered energy of the whole connection is added in separate registers

The meter meets the requirements.

4.1.10 Token carrier acceptor

This test was carried out on meter no. 99710320.

The keypad interface was tested to operate for a minimum of 20.000 operations for each individual key, the insertion force did not exceed 10N.

After the test the keypad interface worked properly.

The token carrier acceptor meets the requirements.

4.2 Tests of climatic influences

4.2.1 General

In order to evaluate the materials used and the construction of the meter, the relevant meter was assessed with regard to the following points.

4.2.2 Dry heat test - Storage and transport

This test was carried out on meter no. 99710295.

The test was carried out according to EN-IEC 60068-2-2, at a temperature of 70 °C for a duration of 72 hours.

Afterwards, the meter showed no damage or loss of information.

4.2.3 Cold test

This test was carried out on meter no. 99710295.

The test was carried out according to IEC 60068-2-1, at a temperature of -25 °C for a duration of 72 hours.

Afterwards the meter showed no damage or loss of information.

4.2.4 Damp heat cyclic test

This test was carried out on meter no. 99710295.

The test was carried out according to IEC 60068-2-30 (variant 1) with an upper temperature of 40 °C for 6 cycles.

An insulation test was carried out. The meter showed no damage or loss of information.

The meter meets the requirements.

4.2.5 Solar radiation test

This test is not applicable to indoor meters.

4.2.6 Crystal-controlled clocks on operation reserve

This test was carried out on meter no. 99710323.

The payment meter to be tested was supplied with power and synchronised with a reference clock. Before the test, the payment meter was powered for a suitable length of time. The power supply to the payment meter under test was switched off for 66 h. When the power supply was restored, the time-indication discrepancy between the reference clock and payment meter under test was 1,04 s (req. < 1,5 s/36 h).

The meter meets the requirements.

4.2.7 Crystal-controlled clocks on a.c. supplies

This test was carried out on meter no. 99710314.

The payment meter to be tested was supplied with power and synchronised with a reference clock. Before the test, the payment meter was powered for a suitable length of time. After a testing period of 66 hours, the time-indication discrepancy between the reference clock and the payment meter under test was 0,11 s (req. < 1,0 s/48 h).

The meter meets the requirements.

4.2.8 Accuracy of crystal-controlled clocks at temperature limits

This test was carried out on meter no 99710312.

The payment meter is placed in a climatic chamber and its time base was measured at +23 °C. The temperature was then set at +45 °C. After a testing period of 64 hours at thermal equilibrium, the time-indication discrepancy between the reference clock and the payment meter under test was 0,59 s (req. < 3,8 s/24 h).

The payment meter is placed in a climatic chamber and its time base was measured at +23 °C. The temperature was then set at -10 °C. After a testing period of 24 hours at thermal equilibrium, the time-indication discrepancy between the reference clock and the payment meter under test was 0,36 s (req. < 5,45 s/24 h).

The meter meets the requirements.

4.3 Accuracy measurement at different loads

These tests were carried out on meter no. 99710303, 99710309, 99710315 and 99710323.

The meters were examined at an ambient temperature of (23 ± 2) °C and after the voltage circuits had been connected to reference voltage for at least 1 hour.

The measuring conditions were as specified in section 8.7.1 of EN 50470-3 and in section 8.5 of IEC 62053-21. The measurements were made with an accurate static energy standard.

The percentage error of the meter can be expressed as follows:

$$p = \frac{PM - PA}{PA} \times 100\%$$

in which

- p = percentage error
- PM = energy recorded by meter
- PA = actual energy.

The values for the errors registered at different currents and various values for $\cos \varphi / \sin \varphi$, at reference voltage and reference frequency, can be found in appendix A. The results show that the static energy meters, under the reference conditions given in section 8.7.1 of EN 50470-3 and in section 8.5 of IEC 62053-21, meet the requirements given in the relevant publication.

4.3.1 Interpretation of test results

There was no need to displace the zero line to bring the errors of the kWh-meters within the limits.

4.3.2 Test of meter constant

A test has been carried out to prove that the relation between the test output and the registered energy (display) is correct.

4.3.3 Starting current

The minimum load at which the energy meters tested recorded Whs at reference voltage, reference frequency and $\cos \varphi = 1$ was less than 0,3 % of I_{ref} (req. $\leq 0,4$ % I_{ref}).

The minimum load at which the energy meters tested recorded varhs at reference voltage, reference frequency and $\sin \varphi = 1$ was less than 0,3 % of I_{ref} (req. $\leq 0,5$ % I_{ref}).

4.3.4 Test of no load condition

At zero current, reference frequency and a voltage of 115 % U_n , no pulse was generated by the energy meters tested.

The meter meets the requirements.

4.3.5 Accuracy measurement at different loads in the Neutral wire

These tests were carried out on meter no. 99710303.

Using the same conditions as listed under 4.3, the accuracy was tested when measuring energy in the Neutral wire. The meter functionality allows the meter to decide if this line is used for current measurement, where normally measurement in the L wire is used. Functionality is described in chapter 2.

The values for the errors registered at different currents and various values for $\cos \varphi / \sin \varphi$, at reference voltage and reference frequency, can be found in appendix A.

The listed results show the wire used for current measurement for each table.

The results show that the static energy meters, under the reference conditions given in section 8.5 of IEC 62053-21/23, meet the requirements given in section 8.1 of the relevant publication.

There was no need to displace the zero line to bring the errors of the kWh-meters within the limits.

A test has been carried out to prove that the relation between the test output and the registered energy (display) is correct.

The minimum load at which the energy meters tested recorded Whs at reference voltage, reference frequency and $\cos \varphi = 1$ was less than 0,3 % of I_b (req. < 0,4 % I_b).

The minimum load at which the energy meters tested recorded varhs at reference voltage, reference frequency and $\sin \varphi = 1$ was less than 0,3 % of I_b (req. \leq 0,5 % I_b).

At zero current, reference frequency and a voltage of 115 % U_n , no pulse was generated by the energy meters tested.

The meter meets the requirements.

4.4 Effect of change of influence quantities on accuracy

4.4.1 Influence of ambient temperature variation

The meter was placed into a climatic room with ambient temperatures as shown in the table below until thermal equilibrium was reached. The measured deviations in the errors according to IEC 62053-21 are shown in the following table.

Serial number 99710303 on L		Wh-measurement							
I in % of I _b	cos φ	Temperature coefficient for the specified temperature range in % per K							
		-40..-25	-25..-10	-10..5	5..23	23..40	40..55	55..70	70..80
5	1	0,002%	0,001%	0,003%	0,008%	0,002%	0,001%	0,007%	0,001%
10	0,5 ind.	0,001%	0,000%	0,003%	0,002%	0,003%	0,004%	0,003%	0,006%
100	1	0,003%	0,003%	0,003%	0,004%	0,005%	0,005%	0,005%	0,004%
100	0,5 ind.	0,003%	0,003%	0,003%	0,004%	0,005%	0,004%	0,003%	0,003%
I _{max}	1	0,001%	0,000%	0,001%	0,002%	0,004%	0,003%	0,004%	0,002%
I _{max}	0,5 ind.	0,000%	0,000%	0,000%	0,001%	0,002%	0,003%	0,003%	0,001%

Serial number 99710309 on L		Wh-measurement							
I in % of I _b	cos φ	Temperature coefficient for the specified temperature range in % per K							
		-40..-25	-25..-10	-10..5	5..23	23..40	40..55	55..70	70..80
5	1	0,007%	0,003%	0,009%	0,003%	0,007%	0,005%	0,005%	0,005%
10	0,5 ind.	0,007%	0,006%	0,005%	0,005%	0,005%	0,003%	0,007%	0,001%
100	1	0,007%	0,005%	0,007%	0,006%	0,006%	0,006%	0,007%	0,006%
100	0,5 ind.	0,006%	0,005%	0,006%	0,005%	0,006%	0,006%	0,006%	0,005%
I _{max}	1	0,003%	0,003%	0,003%	0,003%	0,004%	0,005%	0,006%	0,005%
I _{max}	0,5 ind.	0,003%	0,000%	0,002%	0,002%	0,004%	0,003%	0,005%	0,005%

Serial number 99710303 on N		Wh-measurement							
I in % of I _b	cos φ	Temperature coefficient for the specified temperature range in % per K							
		-40..-25	-25..-10	-10..5	5..23	23..40	40..55	55..70	70..80
5	1	0,005%	0,002%	0,000%	0,003%	0,004%	0,007%	0,009%	0,011%
10	0,5 ind.	0,004%	0,001%	0,001%	0,004%	0,005%	0,009%	0,010%	0,012%
100	1	0,004%	0,002%	0,001%	0,003%	0,006%	0,008%	0,009%	0,011%
100	0,5 ind.	0,004%	0,002%	0,000%	0,003%	0,006%	0,009%	0,010%	0,010%
I _{max}	1	0,005%	0,003%	0,001%	0,003%	0,005%	0,007%	0,009%	0,010%
I _{max}	0,5 ind.	0,005%	0,003%	0,000%	0,002%	0,006%	0,008%	0,010%	0,011%

Serial number 99710303 on N		varh-measurement							
I in % of I _b	sin φ	Temperature coefficient for the specified temperature range in % per K							
		-40..-25	-25..-10	-10..5	5..23	23..40	40..55	55..70	70..80
5	1	0,005%	0,001%	0,002%	0,005%	0,007%	0,009%	0,009%	0,012%
10	0,5 ind.	0,005%	0,003%	0,002%	0,004%	0,007%	0,006%	0,010%	0,006%
100	1	0,005%	0,002%	0,001%	0,004%	0,007%	0,008%	0,009%	0,010%
100	0,5 ind.	0,005%	0,002%	0,001%	0,004%	0,005%	0,009%	0,008%	0,009%
I _{max}	1	0,005%	0,002%	0,002%	0,004%	0,007%	0,008%	0,009%	0,011%
I _{max}	0,5 ind.	0,004%	0,003%	0,002%	0,003%	0,007%	0,007%	0,009%	0,011%

Serial number 99710309 on N		varh-measurement							
I in % of I _b	sin φ	Temperature coefficient for the specified temperature range in % per K							
		-40..-25	-25..-10	-10..5	5..23	23..40	40..55	55..70	70..80
5	1	0,001%	0,001%	0,003%	0,006%	0,008%	0,012%	0,012%	0,011%
10	0,5 ind.	0,001%	0,001%	0,003%	0,005%	0,007%	0,009%	0,010%	0,013%
100	1	0,002%	0,001%	0,004%	0,005%	0,009%	0,010%	0,013%	0,011%
100	0,5 ind.	0,001%	0,001%	0,004%	0,005%	0,009%	0,010%	0,011%	0,012%
I _{max}	1	0,001%	0,001%	0,004%	0,006%	0,009%	0,010%	0,012%	0,012%
I _{max}	0,5 ind.	0,001%	0,001%	0,004%	0,007%	0,008%	0,011%	0,010%	0,012%

The meter meets the requirements.

The measured values of the additional percentage errors according to EN 50470-3 are shown in the following table.

Serial number 99710303 on L		Wh-measurement									
I in % of I _{ref}	cos φ	°C	Additional percentage error due to temperature variation %								
			-40 °C	-25 °C	-10 °C	5 °C	30 °C	40 °C	55 °C	70 °C	80 °C
5	1		-0,16%	-0,13%	-0,11%	-0,15%	0,00%	0,04%	0,05%	0,16%	0,17%
10	1		-0,15%	-0,11%	-0,08%	-0,08%	0,06%	0,08%	0,13%	0,20%	0,17%
10	0,5 ind.		-0,11%	-0,09%	-0,09%	-0,04%	0,07%	0,05%	0,11%	0,15%	0,14%
10	0,8 cap.		-0,18%	-0,14%	-0,12%	-0,09%	0,04%	0,05%	0,11%	0,19%	0,16%
I _{max}	1		-0,06%	-0,05%	-0,05%	-0,03%	0,02%	0,06%	0,10%	0,16%	0,16%
I _{max}	0,5 ind.		-0,01%	-0,01%	-0,01%	-0,01%	0,02%	0,04%	0,08%	0,12%	0,11%
I _{max}	0,8 cap.		0,01%	-0,01%	-0,01%	-0,02%	0,01%	0,04%	0,09%	0,14%	0,16%

Serial number 99710309 on L			Wh-measurement								
I in % of I _{ref}	cos φ	°C	Additional percentage error due to temperature variation %								
			-40 °C	-25 °C	-10 °C	5 °C	30 °C	40 °C	55 °C	70 °C	80 °C
5	1		-0,35%	-0,25%	-0,20%	-0,06%	0,06%	0,12%	0,19%	0,27%	0,32%
10	1		-0,35%	-0,26%	-0,19%	-0,10%	0,01%	0,08%	0,18%	0,25%	0,31%
10	0,5 ind.		-0,36%	-0,25%	-0,16%	-0,09%	0,00%	0,08%	0,12%	0,22%	0,23%
10	0,8 cap.		-0,34%	-0,26%	-0,20%	-0,08%	0,04%	0,10%	0,21%	0,30%	0,33%
I _{max}	1		-0,19%	-0,14%	-0,10%	-0,05%	0,02%	0,06%	0,14%	0,23%	0,34%
I _{max}	0,5 ind.		-0,12%	-0,07%	-0,07%	-0,04%	0,02%	0,06%	0,11%	0,19%	0,32%
I _{max}	0,8 cap.		-0,12%	-0,08%	-0,06%	-0,03%	0,02%	0,05%	0,12%	0,21%	0,36%

Serial number 99710303 on N			Wh-measurement								
I in % of I _{ref}	cos φ	°C	Additional percentage error due to temperature variation %								
			-40 °C	-25 °C	-10 °C	5 °C	30 °C	40 °C	55 °C	70 °C	80 °C
5	1		0,05%	-0,03%	-0,06%	-0,06%	0,02%	0,07%	0,18%	0,32%	0,43%
10	1		0,04%	-0,03%	-0,06%	-0,06%	0,03%	0,08%	0,19%	0,32%	0,44%
10	0,5 ind.		0,02%	-0,04%	-0,06%	-0,07%	0,03%	0,09%	0,22%	0,37%	0,49%
10	0,8 cap.		0,04%	-0,02%	-0,05%	-0,06%	0,02%	0,07%	0,19%	0,31%	0,41%
I _{max}	1		0,07%	-0,01%	-0,06%	-0,05%	0,03%	0,09%	0,20%	0,34%	0,46%
I _{max}	0,5 ind.		0,07%	0,00%	-0,04%	-0,04%	0,03%	0,10%	0,22%	0,37%	0,47%
I _{max}	0,8 cap.		0,06%	-0,02%	-0,05%	-0,04%	0,03%	0,08%	0,19%	0,33%	0,44%

The meter meets the requirements.

4.4.2 Effect of changes in the auxiliary supply voltage

Not applicable.

4.4.3 Voltage variation

These tests were carried out on meter no. 99710303, 99710309, 99710315 and 99710323.

The change in the error due to a 10% change of the measuring voltage over the complete voltage range of the meter was measured at various loads.

The maximum change in error was:

- 0,09% registering Wh at cos φ = 1 (Requirement ≤ 0,7%)
- 0,08% registering Wh at cos φ = 0,5 ind. (Requirement ≤ 1,0%)
- 0,07% registering Wh at cos φ = 0,8 cap. (Requirement ≤ 1,0%)
- 0,11% registering varh at sin φ = 1 (Requirement ≤ 1,0%)
- 0,13% registering varh at sin φ = 0,5 ind. (Requirement ≤ 1,5%).

The meter meets the requirements.

4.4.4 Frequency variation

These tests were carried out on meter no. 99710303, 99710309, 99710315 and 99710323.

The change in the error due to a 2% change of the reference frequency over the complete voltage range of the meter was measured at various loads.

The maximum change in error was:

- 0,10% registering Wh at $\cos \varphi = 1$ (Requirement $\leq 0,5\%$)
- 0,11% registering Wh at $\cos \varphi = 0,5$ ind. (Requirement $\leq 0,7\%$)
- 0,09% registering Wh at $\cos \varphi = 0,8$ cap. (Requirement $\leq 0,7\%$)
- 0,06% registering varh at $\sin \varphi = 1$ (Requirement $\leq 2,5\%$)
- 0,08% registering varh at $\sin \varphi = 0,5$ ind. (Requirement $\leq 2,5\%$).

The meter meets the requirements.

4.4.5 Magnetic induction of external origin 0,5 mT

This test was carried out on meter no. 99710293, 99710304, 99710306 and 99710317.

An external magnetic field was generated using a round coil measuring 1 meter in diameter. The field was applied in all three directions in order to determine the worst-case position. The phase position of the field current (with respect to the measuring voltage) was shifted between 0° and 360° .

The maximum change measured at reference voltage, reference current and reference frequency was 0,91 %. The maximum permissible change allowed by EN 50470-3 and IEC 62053 21 is 2,0%.

The maximum permissible change allowed by IEC 62053-23 is 3,0%.

The meter meets the requirements.

4.4.6 Harmonic components in the current and voltage circuits

These tests were carried out on meter no. 99710303, 99710309, 99710315 and 99710323.

Using the special amplifiers of the meter test equipment, 10% of fifth harmonic was added to the voltage and 40% of fifth harmonic was added to the current. Using a load at $0,5 I_{\max}$, a 4% increase of power in the fifth harmonic in relation to the nominal frequency was generated. The energy measured was compared to the energy measured by the standard equipment.

The worst case change in the error was 0,03 %.

The maximum permissible change allowed by EN 50470-3 and IEC 62053-21 is 0,8%.

The meter meets the requirements.

4.4.7 DC and even harmonics in the a.c. current circuit

This test was carried out on meter no. 99710292, 99710293, 99710304, 99710306, 99710314 and 99710317.

Using diodes, a rectified waveform was generated in the meter current circuits according to Annex C1 of EN 50470-3 and Annex A1 of IEC 62053-21. The energy measured was compared to the energy measured by the standard equipment. The test was carried out at a current of $I_{\max}/\sqrt{2}$. The worst case change in the error was 0,65% in "L" circuit and 1,51% in the "N" circuit. The maximum permissible change allowed by EN 50470-3 and IEC 62053-21 is 3,0%.

The meter meets the requirements.

4.4.8 Odd harmonics in the a.c. current circuit

These tests were carried out on meter no. 99710303, 99710309, 99710315 and 99710323.

Using the special amplifiers of the meter test equipment, a phase-fired waveform was generated in the current circuits according to Annex C2 of EN 50470-3 and Annex A2 of IEC 62053-21. The energy measured was compared to the energy measured by an energy standard. The worst case difference was 0,03%.

The maximum permissible change allowed by EN 50470-3 and IEC 62053-21 is 3,0%.

The meter meets the requirements.

4.4.9 Sub-harmonics in the a.c. current circuit

These tests were carried out on meter no. 99710303, 99710309, 99710315 and 99710323.

Using the special amplifiers of the meter test equipment, a "2 on 2 off cycle burst" was generated in the current circuits according to Annex C3 of EN 50470-3 and Annex A3 of IEC 62053-21. The energy measured was compared to the energy measured by an energy standard. The worst case difference was 0,02%.

The maximum permissible change allowed by EN 50470-3 and IEC 62053-21 is 3,0%.

The meter meets the requirements.

4.4.10 Reversed phase sequence

This test is not applicable to single-phase meters.

4.4.11 Voltage unbalance

This test is not applicable to single-phase meters.

4.4.12 Continuous magnetic induction of external origin

This test was carried out on meter no. 99710304 and 99710306.

The magnetic field was generated using an electromagnet as described in annex E of EN 50470-1 and Annex B of IEC 62053-21. The change in the error due to this magnetic field was less than 0,01% (requirement $\leq 2,0\%$).

The meter meets the requirements.

4.4.13 Operation of accessories

Operation of accessories did not influence the registration of the meter.

4.4.14 Extended Voltage operation range

This test was carried out on meter no. 99710321.

Within specified operating range of $0,8U_n$ to $1,15U_n$, the meter operates correctly.

Within this range, the operation of the power supply circuits, the display, any push buttons, the meter accounting process, any associated registers, values, parameters, the load switch, internal clock and the token carrier interface circuits operates correct.

A valid token was accepted at the first attempt and an invalid token was rejected without damage or cancellation.

The meter meets the requirements.

4.4.15 Abnormal voltage conditions

This test was carried out on meter no. 99710321.

The payment meter shall withstand, without a safety hazard arising, the maximum withstand voltage ($1,9 U_n$) applied between the line voltage and neutral terminals. The maximum withstand voltage was applied for a period of 4 h together with a current of 50% of I_{max} and unity power factor.

The timekeeping facility continued to maintain timekeeping under these conditions.

The deviation of the internal clock for internal tariff control after the tests was < 1 s.

The meter meets the requirements.

4.4.16 3th Harmonic component in the voltage circuits

This test was carried out on meter no. 99710322.

The payment meter was synchronised to a suitable reference clock. Using the special amplifiers of the meter test equipment a third harmonic content equivalent to 10% of U_n is added to the supply voltage of the payment meter under test, symmetrically to each phase. The test is carried out for a period of 66 h under reference conditions.

At the end of the test, the time-indication discrepancy between the payment meter under test and the reference clock was 0,19 s (req. < 1 s / 48 h).

The meter meets the requirements.

4.4.17 Limit Voltage range of operation with voltage.

This test was carried out on meter no. 99710321.

Outside the extended operating range of supply voltage but within the limit range of operation (i.e. from 0,0 U_n to 0,8 U_n) the following tests, under reference conditions, in prepayment mode and mounted under normal service conditions are used, to verify the severe voltage conditions.

- a) The meter was arranged to have a negative value of available credit, such as to ensure that the load switch is open. Readings of the cumulative kWh register and available credit value are then recorded. The supply voltage was then removed.
- b) The supply voltage increased from zero at a steady and progressive rate of approximately 1% of U_n per second with no load current, dwelling at each of the following levels for 60 s: 20% U_n , 40% U_n , 60% U_n , 80% U_n . At 80% U_n the load switch is in the correct position.
- c) After 60 s. at 80% U_n the supply voltage was decreased at a steady and progressive rate of approximately 1% of U_n per second with no load current, dwelling at each of the following levels for 60 s: 70% U_n , 50% U_n , 30% U_n , 10% U_n , before reaching zero.
- d) After 10 s at zero voltage, a supply voltage of 0,8 U_n was applied to the meter and the readings of the cumulative kWh register and available credit value recorded. Sufficient token credit was loaded to ensure that the load switch was closed.

The test sequence in (b), and (c) were then repeated with the load switch closed but no load current applied.

The status of all registers, values, and parameters associated with the meter accounting process are valid and free of corruption.

The deviation of the internal clock for internal tariff control after the tests was < 1 s.

The meter meets the requirements.

4.4.18 Core functional tests within the voltage and temperature range limits

This test was carried out on meter no. 99710320.

Within temperature range specified in the standard (i.e. from -10 °C to 45 °C), the operation of the power supply circuits, the display, push buttons, the meter accounting process, the load switch, the token interface and output circuits are correct.

With the supply voltage applied to the payment meter and the payment meter outside the specified operating range but within the limit range of operation (i.e. from -25 °C to -10 °C and from +45 °C to +55 °C) the token interface and output circuits are correct.

The core functions of the meter are tested in the following conditions:

- lower temperature limit + lower voltage limit (-10 °C tested at -25 °C + 0,8 U_{n-min})
- lower temperature limit + reference voltage (-25 °C + U_{n-min})
- lower temperature limit + reference voltage (-25 °C + U_{n-max})
- lower temperature limit + upper voltage limit (-10 °C tested at -25 °C + 1,15 U_{n-max})
- upper temperature limit + lower voltage limit (+45 °C tested at 55 °C + 0,8 U_{n-min})
- upper temperature limit + reference voltage (+55 °C + U_{n-min})
- upper temperature limit + reference voltage (+55 °C + U_{n-max})
- upper temperature limit + upper voltage limit (+45 °C tested at 55 °C + 1,15 U_{n-max}).

At each condition the payment meter was in the prepayment mode and mounted for normal service. The following core functions were tested:

- a) The meter was prepared by applying a load until the available credits exhausted and the load switch opens automatically. Readings of the cumulative kWh register and available credit value was recorded. The supply voltage removed.
- b) The meter was subjected to the desired temperature limit and the temperature was allowed to stabilise. The supplied voltage was then applied with zero load current and after one minute, the register and value readings are again recorded, and checked for correct retention. An invalid token was presented and checked for correct rejection.
- c) A valid token carrying a suitable amount of credit was then presented to the meter to check token acceptance. The readings were recorded and checked for the correct advance of available credit. The load switch was closed.
- d) The supply voltage was then removed for 5 min and then restored with zero load current. The readings were recorded and checked for correct retention.
- e) A load of I_{max} and unity power factor then was applied so that the available credit reduces and eventually the load switch opens automatically. The readings were recorded and their changes checked for correct reconciliation.

After the above mentioned conditions the deviation of the internal clock for internal tariff control was < 1 s.

Outside the specified operating range but within the limit range of operation and when there was no supply voltage applied to the payment meter, the status of all registers, values, and parameters associated with the meter accounting process are valid and free from corruption and there were no changes to the metrological and functional characteristics of the meter when the supply voltage was subsequently restored.

The meter meets the requirements.

4.5 Effect of short time over currents on the accuracy

This test was carried out on meter no. 99710318.

A current 30 times I_{max} flowed through the current circuit of the energy meter for a period of one half-cycle (10 ms), with the voltage circuits being supplied with nominal voltage.

Both before and after the test the error was measured at reference current, reference voltage, rated frequency and $\cos \varphi = 1$. The difference in the error measured before and after this test is listed below:

Serial No.	Difference in error %	Requirement %
99710318	0,03	$\leq 1,5$

The meter meets the requirements.

4.6 Self-heating

4.6.1 Influence of self-heating on the accuracy

The changes in the error as a result of self-heating with I_{max} , measured at reference voltage, reference frequency, $\cos \varphi = 1$ and also at $\cos \varphi = 0,5$ inductive, are shown in the table below. The changes were measured for at least 60 minutes after connecting the current.

Serial No.	Maximum change %	
	$\cos \varphi = 1$	$\cos \varphi = 0,5$
99710293	0,20 (req. $\leq 0,7$)	0,24 (req. $\leq 1,0$)
99710303	0,12 (req. $\leq 0,7$)	0,16 (req. $\leq 1,0$)
99710323	0,14 (req. $\leq 0,7$)	0,19 (req. $\leq 1,0$)

The meter meets the requirements.

4.6.2 Heating

This test was carried out on meter no. 99710293, 99710303 and 99701323.

The meter was powered with 115% of nominal voltage and maximum current for 2 hours. The maximum temperature rise of the meters was 21 K (req. ≤ 25 K).

The meter meets the requirements.

4.7 Power consumption of the voltage and current circuits

The meters were tested for power consumption at a nominal voltage. The maximum values are shown in the table below.

4.7.1 According: IEC 62053-21 (measured at nominal current)

The meters were tested for power consumption at a nominal voltage. The maximum values are shown in the table below. The power consumption for the current circuits was measured at nominal current.

Serial number	99710295		99710295		99710304		99710306	
Reference voltage	220 V		240 V		220 V		240 V	
Reference frequency	50 Hz		50 Hz		50 Hz		50 Hz	
Voltage circuit	VA 1,23	W 0,61	VA 1,31	W 0,65	VA 1,24	W 0,61	VA 1,32	W 0,65
Current circuit	VA 0,02		VA 0,02		VA 0,02		VA 0,02	

The maximum permissible power consumption for the voltage circuits is 10 VA and 2 W (including the power supply) and for the current circuits 4 VA. The meter meets the requirements.

4.7.2 According to: IEC 62055-31 (measured at I_{max}).

The power consumption for the current circuits was measured at maximum current.

Serial number	99710304		99710306	
Reference Voltage	240 V		240 V	
Reference frequency	50 Hz		50 Hz	
Voltage circuit	1,37 VA	0,67 W	1,36 VA	0,66 W
Current circuit	6,4 VA		6,2 VA	

The maximum permissible power consumption for the voltage circuits is 10 VA and 3 W (including the power supply).

For the current circuits at a nominal voltage of 220 V: 17,6 VA. (0,08% U_n * 100% I_{max}).

For the current circuits at a nominal voltage of 240 V: 19,2 VA. (0,08% U_n * 100% I_{max})

The meter meets the requirements.

4.8 Fast transient burst test

This test was carried out on meter no. 99710292 and 99710312.

4.8.1 Test method

The test was carried out with the current circuit carrying reference current.

The test was carried out in accordance with clause 7.4.7 of EN 50470-1 and 7.5.4 of IEC 62052-11.

4.8.2 Test levels

The test was carried out with a test voltage of 4 kV in accordance with IEC 62052-11.

This test was first performed with the load switch closed. The test was repeated with the load switch open

4.8.3 Test results

The meter was not influenced by the fast transient burst.

The influence of the fast transient burst was less than 0,5% in all cases.

The maximum allowed variation according to IEC 62053-21 is 4,0%.

The maximum allowed variation according to IEC 62053-23 is 4,0%.

Afterwards there was no change in the operating state and the meter continues to operate correctly without any external intervention.

During and after the test the disturbances did not produce any change in time indication discrepancy.

The deviation of the internal clock for internal tariff control was < 1 s.

The meter meets the requirements.

4.9 Electrostatic discharges

This test was carried out on meter no. 99710292 and 99710312.

4.9.1 Test method

The test was carried out in accordance with clause 7.4.5 of EN 50470-1 and 7.5.2 of IEC 62052-11.

4.9.2 Test levels

A discharge voltage of 15 kV (air discharge) respectively 8 kV (contact- / indirect discharge) was applied in accordance with EN 50470-1 and IEC 62052-11.

This test was first performed with the load switch closed. The test was repeated with the load switch open

4.9.3 Test results

The tests with electrostatic discharges did not cause any disturbances of the meter functions.

Afterwards the meter continues to operate correctly without any external intervention.

During and after the test the disturbances did not produce any change in time indication discrepancy.

The deviation of the internal clock for internal tariff control was < 1 s.

The meter meets the requirements.

4.10 Immunity to electromagnetic RF fields

This test was carried out on meter no. 99710292 and 99710312.

4.10.1 Test method

The test with an electromagnetic field was carried out in a GTEM cell in the frequency range from 80 MHz to 2 GHz. The test was carried out in accordance with clause 7.4.6 of EN 50470-1 and 7.5.3 of IEC 62052-11.

The meter was tested at reference voltage.

4.10.2 Test levels

At a field strength of 10 V/m the meter was tested at reference current.

At a field strength of 30 V/m the meter was tested without current.

4.10.3 Test results

The measured variation in error of the meter due to the electromagnetic field was less than 0,5%.

The maximum allowed variation according to EN 50470-3 and IEC 62053-21 is 2,0%.

The maximum allowed variation according to IEC 62053-23 is 3,0

Without current in the current circuits the RF field did not produce a change in the register.

Afterwards the meter continues to operate correctly without any external intervention.

During and after the test the disturbances did not produce any change in time indication discrepancy

The deviation of the internal clock for internal tariff control was < 1 s.

The meter meets the requirements.

4.11 Immunity to conducted disturbances induced by RF fields

This test was carried out on meter no. 99710292 and 99710312.

4.11.1 Test method

The test for immunity to conducted disturbances induced by radio frequency fields was carried out using CDNs in the frequency range from 150 kHz to 80 MHz. The test was carried out in accordance with clause 7.4.8 of EN 50470-1 and 62052-11. The meter was tested at reference voltage.

4.11.2 Test levels

At a field strength of 10 V_{emf} the meter was tested at reference current and without current.

4.11.3 Test results

The measured variation in error of the meter due to the electromagnetic field was less than 0,5%.

The maximum allowed variation according to EN 50470-3 and IEC 62053-21 is 2,0%.

The maximum allowed variation according to IEC 62053-23 is 3,0%.

Without current in the current circuits the RF field did not produce a change in the register.

Afterwards there was no change in the operating state and the meter continues to operate correctly without any external intervention

The deviation of the internal clock for internal tariff control was < 1 s.

The meter meets the requirements.

4.12 Radio interference measurement

This test was carried out on meter no. 99710292 and 99710312 (0,15 MHz to 30 MHz) and 99710320 (30 to 1000 MHz).

4.12.1 Test levels

The test levels were taken from EN 50470-1 clause 7.4.13 and IEC 62052-11 clause 7.5.8. The test was carried out in accordance with EN 55022 and CISPR 22.

4.12.2 Test results

The maximum peak value measured in the frequency range from 0,15 MHz to 30 MHz (according to EN 55022) was measured at 410 kHz and was 5 dB below the limit.

In the frequency range from 30 to 1000 MHz the maximum peak value measured was measured at 59,49 MHz and was 5 dB below the limit maximum allowed peak value.

The meter meets the requirements.

4.13 Voltage dips and short interruptions

This test was carried out on meter no. 99710304 and 99710306.

4.13.1 Test levels

The test levels were taken from EN 50470-1 clause 7.4.4 and IEC 62052-11 clause 7.1.2.

4.13.2 Test results

The results of the measurements are mentioned below.

Applied phenomena in the line voltage	Duration of the phenomenon	Requirement	Result
Variation in the line voltage $V_{ref} - 50\%$	1 min.	1 min.	Pass
Interruption in the line voltage 3 times with 50 ms restoring time	See annex C of EN 50470-1 or annex B of IEC 62052-11		Pass
Interruption in the line voltage 50Hz	20 ms	20 ms	Pass

The meter meets the requirements.

4.13.3 The results according IEC 62055-31 Annex D

This test was carried out on meter no. 99710314.

Applied phenomena in the line voltage	Duration of the phenomenon	Requirement	Result
Variation in the line voltage $V_{ref} - 50\%$	2min.	2min.	Pass
Interruption time 100ms in the line voltage, 20 times with at least 5 seconds intervals	See annex D of IEC 62055-31		Pass
Interruption time 1s in the line voltage, 20 times with at least 5 seconds intervals	See annex D of IEC 62055-31		Pass

After the test the time indication discrepancy between the payment meter under test and reference clock was:

- After 20 interruptions, 100 msec. : + 0,02 sec. (req. < 1 s).
- After 20 interruptions, 1 sec. : - 0,01 sec. (req. < 1 s).
- After 2 minutes dip : - 0,01 sec. (req. < 1 s).

The meter meets the requirements.

4.14 Surge immunity test

This test was carried out on meter no. 99710292 and 99710322.

4.14.1 Test method

The test was carried out in accordance with clause 7.4.9 of EN 50470-1 and clause 7.5.6 of IEC 62052-11 using a surge generator with impedances as specified in the standard.

4.14.2 Test levels

The test levels were taken from EN 50470-1 clause 7.4.9 and IEC 62052-11 clause 7.5.6.

4.14.3 Test results

The meter was not influenced by the surges. The surges did not produce a change in the register. The meter did not show any damage after the tests.

Afterwards the meter continues to operate correctly without any external intervention. During and after the test the disturbances did not produce any change in time indication discrepancy.

The deviation of the internal clock for internal tariff control was < 1 s.

The meter meets the requirements.

4.15 Damped oscillatory waves immunity test

This test is not applicable to direct connected meters.

4.16 Insulation

This test was carried out on meter no. 99710295.

The auxiliary circuits operating at a reference voltage equal to or below 40 V were connected to earth.

4.16.1 Impulse voltage test

The test was carried out in accordance with clause 7.3.3 of EN 50470-1 and 7.3.2 of IEC 62052-11.

Applied pulse	1,2 / 50 μ s pulse ; $R_i = 500 \Omega$			
	Specification of circuits(s)	Amplitude (open voltage)		Result
			Requirement	
Between input leads (differential mode)	Between leads voltage circuit	6 kV	6 kV	Pass
Between input circuits and earth (common mode)	Between system and earth	6 kV	6 kV	Pass

The change in accuracy due to the test was 0,04%. The meter meets the requirement.

4.16.2 A.C. voltage test

The test was carried out in accordance with clause 7.3.4 of EN 50470-1 and clause 7.3.3 of IEC 62052-11.

A voltage of 4 kV (Protective class II) at a frequency of 50 Hz was applied between system and earth.

During the tests no flashovers were observed. After the tests had been carried out no degradation in the measured insulation resistance was found.

The change in accuracy due to the test was 0,04%.

The meter meets the requirement.

4.17 Immunity to conducted disturbances 2-150 kHz

This test was carried out on meter no. 99710292.

4.17.1 Test method

Immunity to conducted disturbances in the frequency range 2-150 kHz was tested in accordance with EN 61000-4-19 dated August 2014.

The test was carried out for current only, while applying the performance criteria, including the value of the disturbing current, as laid down in chapter 7 (table 2 and 3) of document CLC/TR 50579 (dated June 2012).

The test was carried out by direct injection using a generator, amplifier and decoupling impedances. The meter was tested at reference voltage and reference current.

4.17.2 Test levels

The wave profiles of EN 61000-4-19 were applied.

The value of the disturbing current was 2 A in the range of 2 kHz to 30 kHz and 1 A in the range of 30 kHz to 150 kHz; in accordance with table 2 of CLC/TR 50579.

4.17.3 Test results

The measured variation in error of the meter due to the disturbing current was less than 0,5 %.

The maximum allowed variation according to of CLC/TR 50579 is 4%.

The meter meets the requirements.

5 MAXIMUM PERMISSIBLE ERROR

In accordance with clause 8.4 of EN 50470-3, the composite error is calculated at several temperatures and tested to the maximum permissible error. The calculated values of the composite error are shown in the following table.

Serial No.: 99710303 220V in L

I in % of I _{ref}	cos φ	°C	Composite error %								
			-40 °C	-25 °C	-10 °C	5 °C	30 °C	40 °C	55 °C	70 °C	80 °C
5	1		0,21%	0,18%	0,17%	0,20%	0,13%	0,13%	0,14%	0,21%	0,21%
10	1		0,17%	0,14%	0,12%	0,12%	0,11%	0,12%	0,16%	0,22%	0,19%
10	0,5 ind.		0,14%	0,12%	0,12%	0,09%	0,11%	0,10%	0,14%	0,17%	0,16%
10	0,8 cap.		0,21%	0,18%	0,16%	0,14%	0,12%	0,12%	0,16%	0,22%	0,19%
I _{max}	1		0,11%	0,10%	0,10%	0,10%	0,09%	0,11%	0,13%	0,18%	0,18%
I _{max}	0,5 ind.		0,08%	0,08%	0,08%	0,08%	0,08%	0,08%	0,11%	0,14%	0,13%
I _{max}	0,8 cap.		0,11%	0,11%	0,11%	0,11%	0,11%	0,12%	0,14%	0,18%	0,20%

Serial No.: 99710309 240V in L

in % of I _{ref}	cos φ	°C	Composite error %								
			-40 °C	-25 °C	-10 °C	5 °C	30 °C	40 °C	55 °C	70 °C	80 °C
5	1		0,38%	0,28%	0,24%	0,15%	0,15%	0,18%	0,23%	0,30%	0,35%
10	1		0,36%	0,27%	0,21%	0,13%	0,09%	0,12%	0,20%	0,26%	0,32%
10	0,5 ind.		0,37%	0,26%	0,18%	0,12%	0,08%	0,12%	0,15%	0,24%	0,24%
10	0,8 cap.		0,37%	0,30%	0,25%	0,17%	0,15%	0,18%	0,26%	0,33%	0,36%
I _{max}	1		0,20%	0,15%	0,12%	0,08%	0,06%	0,08%	0,15%	0,24%	0,34%
I _{max}	0,5 ind.		0,17%	0,13%	0,13%	0,12%	0,12%	0,13%	0,16%	0,22%	0,34%
I _{max}	0,8 cap.		0,16%	0,13%	0,12%	0,11%	0,11%	0,11%	0,16%	0,23%	0,37%

Serial No.: 99710303 220V in N

I in % of I _{ref}	cos φ	°C	Composite error %								
			-40 °C	-25 °C	-10 °C	5 °C	30 °C	40 °C	55 °C	70 °C	80 °C
5	1		0,12%	0,12%	0,13%	0,13%	0,11%	0,13%	0,21%	0,34%	0,44%
10	1		0,12%	0,11%	0,12%	0,12%	0,11%	0,13%	0,22%	0,34%	0,45%
10	0,5 ind.		0,14%	0,14%	0,15%	0,15%	0,14%	0,16%	0,26%	0,39%	0,51%
10	0,8 cap.		0,12%	0,12%	0,13%	0,13%	0,12%	0,14%	0,22%	0,33%	0,43%
I _{max}	1		0,10%	0,07%	0,09%	0,09%	0,08%	0,11%	0,21%	0,35%	0,47%
I _{max}	0,5 ind.		0,26%	0,25%	0,25%	0,25%	0,25%	0,27%	0,33%	0,45%	0,53%
I _{max}	0,8 cap.		0,07%	0,04%	0,06%	0,05%	0,04%	0,09%	0,19%	0,33%	0,44%

The meter meets the requirements.

6 DURABILITY AND RELIABILITY

In accordance with chapter 9 and 10 of EN 50470-3 durability and reliability of the meters were verified.

In order to conform to these clauses the manufacturer provided the documentation for verification to KEMA Laboratories and additional verification tests were carried out on request of KEMA Laboratories.

The meter meets the requirements.

7 SOFTWARE AND PROTECTION AGAINST CORRUPTION

In accordance with chapter 11 of EN 50470-3 software and protection against corruption of the meters were verified.

In order to conform to these clauses the manufacturer provided the documentation for verification to KEMA Laboratories. The description of applied methods was based on Welmec guide 7.2 and includes application of the following methods (for risk class C):

I3 – Specific software requirements (Active electrical energy meters)

P – Specific requirements for type P (built-for-Purpose measuring instruments)

L - Specific Software Requirements for Long term storage

The final version of the legally relevant software to be applied is version HMSP1626001G3P0000998BK190505110.

The meter meets the requirements.

8 TOKEN HANDLING

8.1 Interruptions to token acceptance

This test is not applicable for keypad meters.

8.2 Token acceptance

This test was carried out on meter no. 99710320.

The acceptance of a valid token results in the exact amount of credit on the token carrier being transferred to the appropriate register(s) in the payment meter, and the available credit value in the meter was incremented by exactly this amount.

The meter meets the requirement.

8.3 Rejection of duplicate tokens

This test was carried out on meter no. 99710320.

The payment system operation is based on meter-specific tokens for single use, the payment meter ensures that no customer token intended for single use may be actioned more than once, including where token acceptance has been interrupted.

If the token is presented for the second time, the token is rejected, the information on the display shows "USED".

The meter meets the requirement.

8.4 Rejection of valid tokens when available credit is saturated

This test was carried out on meter no 99710320.

A valid token was presented to the payment meter that resulted in the amount of available credit exceeding the maximum amount possible in the meter. The token was rejected. The token was not erased or invalidated. At a later time when the conditions allowed, the token was presented again and accepted.

The meter meets the requirement.

8.5 Energy register roll-over

This test was carried out on meter no. 99710320.

The cumulative kWh register was set near to its maximum reading and sufficient available credit was provided to allow for register roll-over. The maximum meter load was applied sufficient to cause rollover of the cumulative kWh register. The rollover proceeds correctly with the deduction of the available credit value corresponding to the advance of the kWh register.

The execution of this test was performed by the manufacturer as agreed between the manufacturer and test lab.

The meter meets the requirement.

8.6 Token carrier interface test

This test is not applicable for keypad meters.

9 LOAD SWITCH REQUIREMENTS

9.1 Load switching capabilities

Summary of test currents for the switch:

Test clause		UC3
C.3	Electrical endurance	100 A
C.5	Fault current making capacity	3,0 kA
C.6	Short-circuit current carrying capacity – test 1	6,0 kA
C.6	Short-circuit current carrying capacity – test 2	3,0 kA

9.2 Electrical endurance

This test was carried out on sample No. 99710316.

The test was carried out in accordance with clause C.3 of IEC 62055-31.

9.2.1 Required test values

1st 5000 cycles at 10 seconds make time and 20 seconds break time.

Type of circuit : L + N
 Voltage : 230 Vac
 Current : 100 A
 Power factor : 1,00

2nd 5000 cycles at 10 seconds make time and 20 seconds break time.

Type of circuit : L + N
 Voltage : 230 Vac
 Current : 100 A
 Power factor : 0,50 ind.

9.2.2 Test circuit

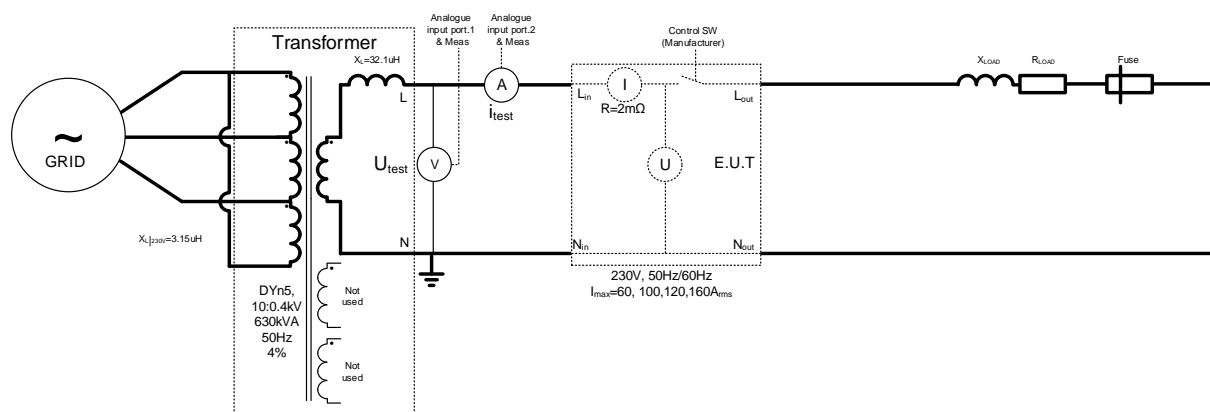

Phase	Part of test	Power factor	Appendix D – plot no.	Contact welded	Result
L1	Shot 1	1.0	Figure 1	No	Pass
L1	Shot 5000	1.0	-	No	Pass
L1	Shot 1	0.5	Figure 2	No	Pass
L1	Shot 5000	0.5	-	No	Pass

current 96,1 A
Voltage 226,5 V
Power factor 1,0
break time $t_{on} = 10$ s
 $t_{off} = 20$ s

current 98,8 A
Voltage 231,4 V
Power factor 0,52
break time $t_{on} = 10$ s
 $t_{off} = 20$ s

9.2.3 Minimum switched current Test conditions:

9.2.3.1 Test method

The test was carried out at reference voltage, minimum switch current and power factor 1,0.
The test was carried out in accordance with clause C7 of IEC 62055-31.

9.2.3.2 Test levels

Execute 10 operating cycles at approximately 10 s closed and 20 s open.

9.2.3.3 Test results

The test current shall successfully conduct each time the contacts are in the closed position.
The test current shall successfully break each time the contacts are in the open position.

The meter meets the requirements.

9.2.4 Power consumption

The power consumption is measured according: IEC 62055-31 (measured at I_{max}).

Reference Voltage	230 V	
Reference frequency	50 Hz	
Voltage circuit	2,21 VA	1,07 W
Current circuit	16,4 VA	

The maximum permissible power consumption for the voltage circuits is 10 VA and 3 W (including the power supply).

For the current circuits at a nominal voltage of 220 V: 17,6 VA. ($0,08\% U_n * 100\% I_{max}$).

For the current circuits at a nominal voltage of 240 V: 19,2 VA. ($0,08\% U_n * 100\% I_{max}$)

The meter meets the requirements.

9.2.5 Impulse voltage test

The test was carried out in accordance with clause C8 of IEC 62055-31 with open switch.

Applied pulse : 1,2 / 50 μ s pulse ; $R_i = 500 \Omega$			
Specification of circuits(s)	Amplitude (open voltage)		Result
		Requirement	
Over the open contacts of the switch	2 kV	2 kV	Pass

During the tests no flashovers were observed. After the tests had been carried out no degradation in the measured insulation resistance was found and the meter operates correctly with no change in any of the memory registers.

The meter meets the requirement.

9.2.6 A.C. voltage test

The test was carried out in accordance with clause C8 of IEC 62055-31 with open switch.

A voltage of 1 kV at a frequency of 50 Hz was applied over the open contacts of the switch.

During the tests no flashovers were observed. After the tests had been carried out there was no change in any of the memory registers.

The meter meets the requirement.

9.3 Fault current making capacity

This test was carried out on sample No. 99710319.

The test was carried out in accordance with clause C.5 of IEC 62055-31.

9.3.1 Required test values

3 times making on the prospective short circuit current.

Type of circuit	:	L + N
Voltage (+5% ... -5%)	:	276 Vac (115%Un)
Current (+5% ... -0%)	:	3000 A
Utilisation category	:	UC3
Power factor (+0.00 ... -0.05)	:	0,85 – 0,90

9.3.2 Test circuit

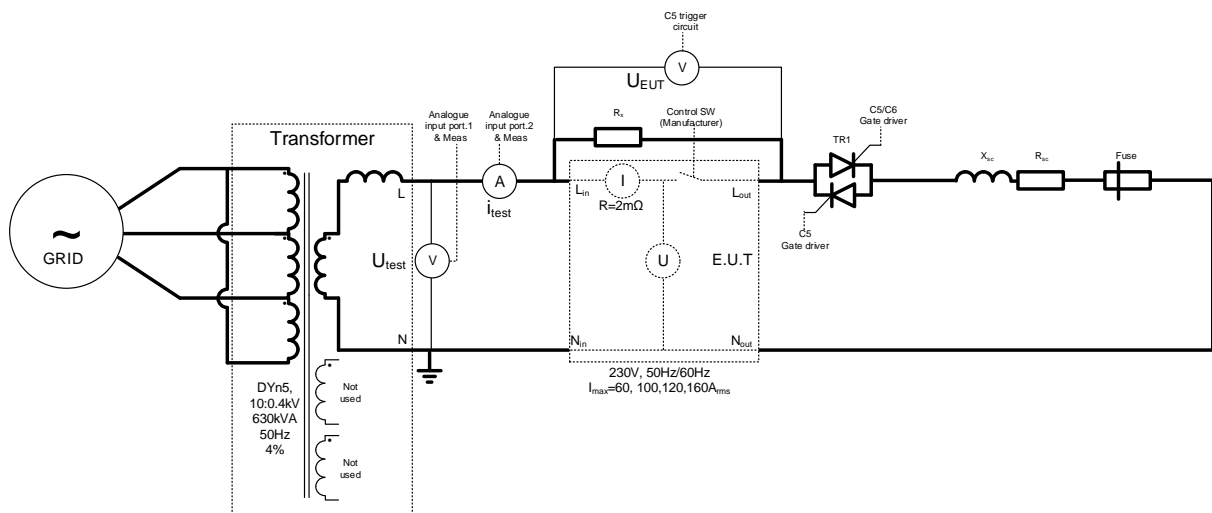

9.3.3 Pre-fusing cycles

3 cycles of pre fusing at I_c with a power factor 1,0 at an interval of 10 seconds.

The meter meets the requirements.

9.3.4 Fault current making capacity

Initial measurement

Voltage Vac	Peak current A	r.m.s. current A	Power factor
272,6	4410	3118	0,77

Test shots

Phase	Voltage Vac	Peak current A	r.m.s. current A	Power factor
L1	273,5	3130	2213	0,71
L1	273,4	4390	3104	0,76
L1	273,6	4000	2828	0,73

Phase	Part of test	Appendix D – plot no.	Contact welded	Result
	Initial	Figure 3	-	-
L1	Shot 1	Figure 4	No	Pass
L1	Shot 2	Figure 5	No	Pass
L1	Shot 3	Figure 6	No	Pass

9.3.5 Minimum switched current Test conditions

9.3.5.1 Test method

The test was carried out at reference voltage, minimum switch current and power factor 1,0.
The test was carried out in accordance with clause C7 of IEC 62055-31.

9.3.5.2 Test levels

Execute 10 operating cycles at approximately 10 s closed and 20 s open.

9.3.5.3 Test results

The test current shall successfully conduct each time the contacts are in the closed position.
The test current shall successfully break each time the contacts are in the open position.

The meter meets the requirements.

9.3.6 Power consumption

The power consumption is measured according: IEC 62055-31 (measured at I_{max}).

Reference Voltage	240 V	
Reference frequency	50 Hz	
Voltage circuit	1,37 VA	0,67 W
Current circuit	5,41 VA	

The maximum permissible power consumption for the voltage circuits is 10 VA and 3 W (including the power supply).

For the current circuits at a nominal voltage of 220 V: 17,6 VA. ($0,08\% U_n * 100\% I_{max}$).

For the current circuits at a nominal voltage of 240 V: 19,2 VA. ($0,08\% U_n * 100\% I_{max}$)

The meter meets the requirements.

9.3.7 Impulse voltage test

The test was carried out in accordance with clause C8 of IEC 62055-31 with open switch.

Applied pulse : 1,2 / 50 μ s pulse ; $R_i = 500 \Omega$			
Specification of circuits(s)	Amplitude (open voltage)		Result
		Requirement	
Over the open contacts of the switch	2 kV	2 kV	Pass

During the tests no flashovers were observed. After the tests had been carried out no degradation in the measured insulation resistance was found and the meter operates correctly with no change in any of the memory registers.

The meter meets the requirement.

9.3.8 A.C. voltage test

The test was carried out in accordance with clause C8 of IEC 62055-31 with open switch.

A voltage of 1 kV at a frequency of 50 Hz was applied over the open contacts of the switch.

During the tests no flashovers were observed. After the tests had been carried out there was no change in any of the memory registers.

The meter meets the requirement.

9.4.4 Short-circuit current carrying capacity

Initial measurement

Voltage Vac	Peak current A	r.m.s. current A	Power factor
268,6	8780	6208	0,65

Test shots

Phase	Voltage Vac	Peak current A	r.m.s. current A	Power factor
L1	270.4	8830	6244	0,64
L1	270.1	8830	6244	0,64
L1	270.4	8830	6244	0,64

Phase	Part of test	Appendix D – plot no.	Contact welded	Result
	Initial	Figure 7	-	-
L1	Shot 1	Figure 8	No	Pass
L1	Shot 2	Figure 9	No	Pass
L1	Shot 3	Figure 10	Yes	Pass

It is permissible that the contacts may weld or burn away, no hazardous live parts have been exposed, and no fire occurred. Therefore the "stay safe" test is pass but the requirements for "stay operational" are not met, the "stay operational" test needs to be performed.

9.4.5 Minimum switched current Test conditions

Not tested.

9.4.1 Power consumption

Not tested.

9.4.2 Impulse voltage test

Not tested.

9.4.3 A.C. voltage test

Not tested.

9.5 Short-circuit carrying capacity, test 2

This test was carried out on sample No. 99710318.

The test was carried out in accordance with clause C.6 of IEC 62055-31.

9.5.1 Required test values

3 times making on the prospective short circuit current.

Type of circuit	:	L + N
Voltage (+5% ... -5%)	:	276 Vac (115%Un)
Current (+5% ... -0%)	:	3000 A
Utilisation category	:	UC3
Power factor (+0.00 ... -0.05)	:	0,85 – 0,90

9.5.2 Test circuit

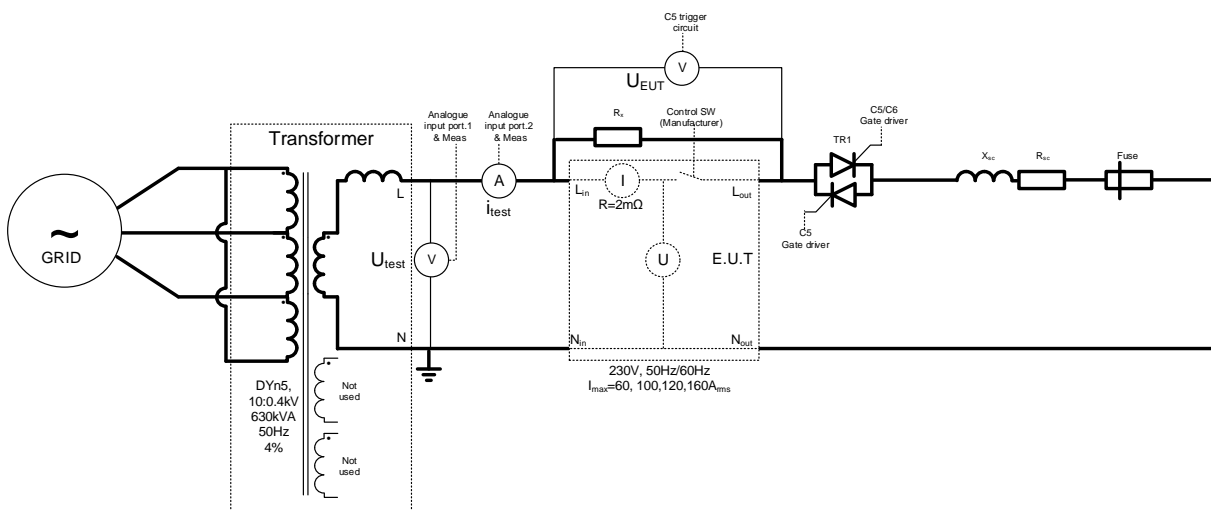

9.5.3 Pre-fusing cycles

3 cycles of pre fusing at I_c with a power factor 1,0 at an interval of 10 seconds.
The meter meets the requirement.

9.5.4 Short-circuit current carrying capacity

Initial measurement

Voltage Vac	Peak current A	r.m.s. current A	Power factor
276,3	4440	3140	0,78

Test shots

Phase	Voltage Vac	Peak current A	r.m.s. current A	Power factor
L1	276,7	4510	3189	0,73
L1	276,3	4490	3174	0,73
L1	277,1	4500	3182	0,77

Phase	Part of test	Appendix D – plot no.	Contact welded	Result
	Initial	Figure 11	-	-
L1	Shot 1	Figure 12	No	Pass
L1	Shot 2	Figure 13	No	Pass
L1	Shot 3	Figure 14	No	Pass

9.5.5 Minimum switched current Test conditions:

9.5.5.1 Test method

The test was carried out at reference voltage, minimum switch current and power factor 1,0.
The test was carried out in accordance with clause C7 of IEC 62055-31.

9.5.5.2 Test levels

Execute 10 operating cycles at approximately 10 s closed and 20 s open.

9.5.5.3 Test results

The test current shall successfully conduct each time the contacts are in the closed position.
The test current shall successfully break each time the contacts are in the open position.

The meter meets the requirements.

9.5.6 Power consumption

The power consumption is measured according: IEC 62055-31 (measured at I_{max}).

Reference Voltage	240 V	
Reference frequency	50 Hz	
Voltage circuit	1,24 VA	0,61 W
Current circuit	5,56 VA	

The maximum permissible power consumption for the voltage circuits is 10 VA and 3 W (including the power supply).

For the current circuits at a nominal voltage of 220 V: 17,6 VA. (0,08% $U_n * 100\% I_{max}$).

For the current circuits at a nominal voltage of 240 V: 19,2 VA. (0,08% $U_n * 100\% I_{max}$)

The meter meets the requirements.

9.5.7 Impulse voltage test

The test was carried out in accordance with clause C8 of IEC 62055-31 with open switch.

Applied pulse : 1,2 / 50 μ s pulse ; $R_i = 500 \Omega$			
Specification of circuits(s)	Amplitude (open voltage)		Result
		Requirement	
Over the open contacts of the switch	2 kV	2 kV	Pass

During the tests no flashovers were observed. After the tests had been carried out no degradation in the measured insulation resistance was found and the meter operates correctly with no change in any of the memory registers.

The meter meets the requirement.

9.5.8 A.C. voltage test

The test was carried out in accordance with clause C8 of IEC 62055-31 with open switch.

A voltage of 1 kV at a frequency of 50 Hz was applied over the open contacts of the switch.

During the tests no flashovers were observed. After the tests had been carried out there was no change in any of the memory registers.

The meter meets the requirement.

Appendix A Accuracy test results

Accuracy test results, serial number 99710315.

240 V in L		Wh			
I in % of I _n	Percentage error at cos φ =				
	1	0,5 ind.	0,8 cap.	0,25 ind.	0,5 cap.
5	0,00%				
5 ¹⁾	0,09%				
10	0,03%	-0,01%	0,03%		
20	0,03%	-0,01%	0,04%	-0,02%	0,06%
50	0,02%	0,01%	0,04%	0,00%	0,04%
100	0,03%	0,00%	0,03%	0,00%	0,04%
100 ¹⁾	0,03%	0,02%	0,03%		
200	0,02%	0,00%	0,03%		
½I _{max}	0,02%	0,00%	0,04%		
¾I _{max}	0,02%	0,00%	0,04%		
I _{max}	0,01%	-0,06%	-0,03%		

¹⁾ Reverse energy

Accuracy test results, serial number 99710303.

220 V in L		Wh			
I in % of I _n	Percentage error at cos φ =				
	1	0,5 ind.	0,8 cap.	0,25 ind.	0,5 cap.
5	-0,09%				
5 ¹⁾	-0,03%				
10	-0,06%	-0,01%	-0,09%		
20	-0,04%	-0,03%	-0,07%	0,00%	-0,10%
50	-0,05%	-0,02%	-0,06%	0,00%	-0,09%
100	-0,04%	-0,01%	-0,06%	0,02%	-0,08%
100 ¹⁾	-0,04%	0,00%	-0,06%		
200	-0,04%	-0,01%	-0,06%		
½I _{max}	-0,05%	-0,02%	-0,07%		
¾I _{max}	-0,05%	-0,03%	-0,08%		
I _{max}	-0,08%	-0,06%	-0,11%		

¹⁾ Reverse energy

Accuracy test results, serial number 99710303.

220 V in N		Wh			
I in % of I _n	Percentage error at cos φ =				
	1	0,5 ind.	0,8 cap.	0,25 ind.	0,5 cap.
5	-0,11%				
5 ¹⁾	0,13%				
10	-0,03%	-0,07%	-0,07%		
20	-0,02%	-0,03%	-0,03%	-0,06%	-0,06%
50	-0,01%	-0,01%	-0,02%	-0,02%	-0,03%
100	0,00%	-0,01%	-0,01%	-0,03%	-0,01%
100 ¹⁾	0,00%	0,01%	0,00%		
200	-0,01%	-0,04%	0,00%		
½I _{max}	-0,05%	-0,19%	0,00%		
¾I _{max}	-0,06%	0,05%	-0,07%		
I _{max}	-0,07%	-0,25%	-0,01%		

1) Reverse energy

Accuracy test results, serial number 99710309.

240 V in L		Wh			
I in % of I _n	Percentage error at cos φ =				
	1	0,5 ind.	0,8 cap.	0,25 ind.	0,5 cap.
5	0,10%				
5 ¹⁾	0,08%				
10	0,08%	-0,03%	0,13%		
20	0,09%	-0,04%	0,13%	-0,15%	0,18%
50	0,07%	-0,02%	0,13%	-0,18%	0,19%
100	0,07%	-0,01%	0,12%	-0,14%	0,18%
100 ¹⁾	0,08%	-0,01%	0,12%		
200	0,07%	-0,01%	0,13%		
½I _{max}	0,08%	-0,02%	0,12%		
¾I _{max}	0,07%	-0,04%	0,11%		
I _{max}	0,04%	-0,10%	0,07%		

1) Reverse energy

Accuracy test results, serial number 99710323.

220 V in N		Wh			
I in % of I _n	Percentage error at cos φ =				
	1	0,5 ind.	0,8 cap.	0,25 ind.	0,5 cap.
5	-0,03%				
5 ¹⁾	0,05%				
10	-0,02%	0,00%	-0,04%		
20	0,00%	0,02%	-0,02%	0,03%	-0,04%
50	0,00%	0,00%	-0,02%	0,03%	-0,03%
100	-0,01%	0,00%	-0,01%	0,00%	-0,02%
100 ¹⁾	0,00%	0,00%	0,00%		
200	-0,02%	-0,03%	0,00%		
½I _{max}	-0,01%	0,42%	-0,26%		
¾I _{max}	-0,02%	-0,16%	0,03%		
I _{max}	-0,02%	-0,19%	0,03%		

1) Reverse energy

Accuracy test results, serial number 99710323.

240 V in L+N		Wh			
I in % of I _n	Percentage error at cos φ =				
	1	0,5 ind.	0,8 cap.	0,25 ind.	0,5 cap.
5	-0,07%				
5 ¹⁾	0,09%				
10	-0,04%	-0,03%	-0,04%		
20	0,00%	0,01%	-0,01%	0,01%	-0,06%
50	0,00%	0,01%	-0,01%	0,03%	-0,02%
100	0,00%	0,01%	0,00%	0,03%	0,00%
100 ¹⁾	0,01%	0,01%	0,00%		
200	0,00%	-0,01%	0,02%		
½I _{max}	-0,01%	-0,16%	0,04%		
¾I _{max}	-0,02%	-0,20%	0,05%		
I _{max}	-0,01%	-0,20%	0,06%		

1) Reverse energy

Accuracy test results, serial number 99710303.

240 V in N		varh			
I in % of I_n	Percentage error at $\sin \varphi =$				
	1	0,5 ind.	0,5 cap.	0,25 ind.	0,25 cap.
5	0,22%				
5 ¹⁾	-0,21%				
10	0,11%	0,21%	0,25%		
20	0,06%	0,11%	0,12%	0,22%	0,23%
50	0,01%	0,04%			
100	0,00%	0,03%	0,00%	0,07%	0,01%
100 ¹⁾	-0,01%	0,00%	-0,04%		
200	0,00%	0,04%			
$\frac{1}{2}I_{max}$	-0,02%	0,10%	-0,15%	0,23%	-0,33%
$\frac{3}{4}I_{max}$	-0,02%	-0,49%			
I_{max}	-0,03%	0,11%	-0,17%	0,22%	-0,38%

¹⁾ Exported energy

Accuracy test results, serial number 99710315.

240 V		varh			
I in % of I_n	Percentage error at $\sin \varphi =$				
	1	0,5 ind.	0,5 cap.	0,25 ind.	0,25 cap.
5	-0,88%				
5 ¹⁾	0,98%				
10	-0,44%	-0,87%	-0,90%		
20	-0,20%	-0,39%	-0,45%	-0,82%	-0,95%
50	-0,07%	-0,13%			
100	-0,01%	-0,04%	-0,10%	-0,11%	-0,24%
100 ¹⁾	0,08%	0,16%	0,11%		
200	0,01%	0,01%			
$\frac{1}{2}I_{max}$	0,02%	0,04%	-0,01%	0,06%	-0,08%
$\frac{3}{4}I_{max}$	0,08%	0,09%			
I_{max}	0,04%	0,03%	-0,08%	0,01%	-0,18%

¹⁾ Exported energy

Accuracy test results, serial number 99710315.

220 V		varh			
I in % of I_n	Percentage error at $\sin \varphi =$				
	1	0,5 ind.	0,5 cap.	0,25 ind.	0,25 cap.
5	-0,79%				
5 ¹⁾	0,95%				
10	-0,32%	-0,72%	-0,79%		
20	-0,11%	-0,29%	-0,35%	-0,68%	-0,83%
50	-0,01%	-0,08%			
100	0,04%	0,02%	-0,03%	-0,04%	-0,16%
100 ¹⁾	0,14%	0,21%	0,15%		
200	0,07%	0,07%			
$\frac{1}{2}I_{max}$	0,08%	0,11%	0,03%	0,14%	-0,04%
$\frac{3}{4}I_{max}$	0,08%	0,10%			
I_{max}	0,04%	0,01%	-0,11%	0,01%	-0,20%

¹⁾ Exported energy

Accuracy test results, serial number 99710323.

220 V in L+N		varh			
I in % of I_n	Percentage error at $\sin \varphi =$				
	1	0,5 ind.	0,5 cap.	0,25 ind.	0,25 cap.
5	-1,13%				
5 ¹⁾	0,84%				
10	-0,62%	-1,06%	-1,18%		
20	-0,36%	-0,54%	-0,68%	-0,95%	-1,27%
50	-0,21%	-0,26%			
100	-0,16%	-0,14%	-0,29%	-0,14%	-0,44%
100 ¹⁾	-0,06%	-0,07%	0,03%		
200	-0,14%	-0,11%			
$\frac{1}{2}I_{max}$	-0,07%	-0,08%	-0,21%	-0,01%	-0,32%
$\frac{3}{4}I_{max}$	-0,06%	-0,09%			
I_{max}	-0,08%	-0,13%	-0,26%	-0,06%	-0,36%

¹⁾ Exported energy

Accuracy test results, serial number 99710323.

240 V in L+N		varh			
I in % of I_n	Percentage error at $\sin \varphi =$				
	1	0,5 ind.	0,5 cap.	0,25 ind.	0,25 cap.
5	-1,17%				
5 ¹⁾	1,00%				
10	-0,63%	-1,08%	-1,19%		
20	-0,33%	-0,54%	-0,67%	-0,98%	-1,27%
50	-0,18%	-0,22%			
100	-0,12%	-0,10%	-0,25%	-0,11%	-0,42%
100 ¹⁾	-0,01%	-0,01%	0,09%		
200	-0,09%	-0,05%			
$\frac{1}{2}I_{max}$	-0,06%	-0,03%	-0,16%	0,04%	-0,26%
$\frac{3}{4}I_{max}$	-0,07%	-0,03%			
I_{max}	-0,07%	-0,08%	-0,23%	0,00%	-0,33%

¹⁾ Exported energy

Appendix B Photographs of the meter





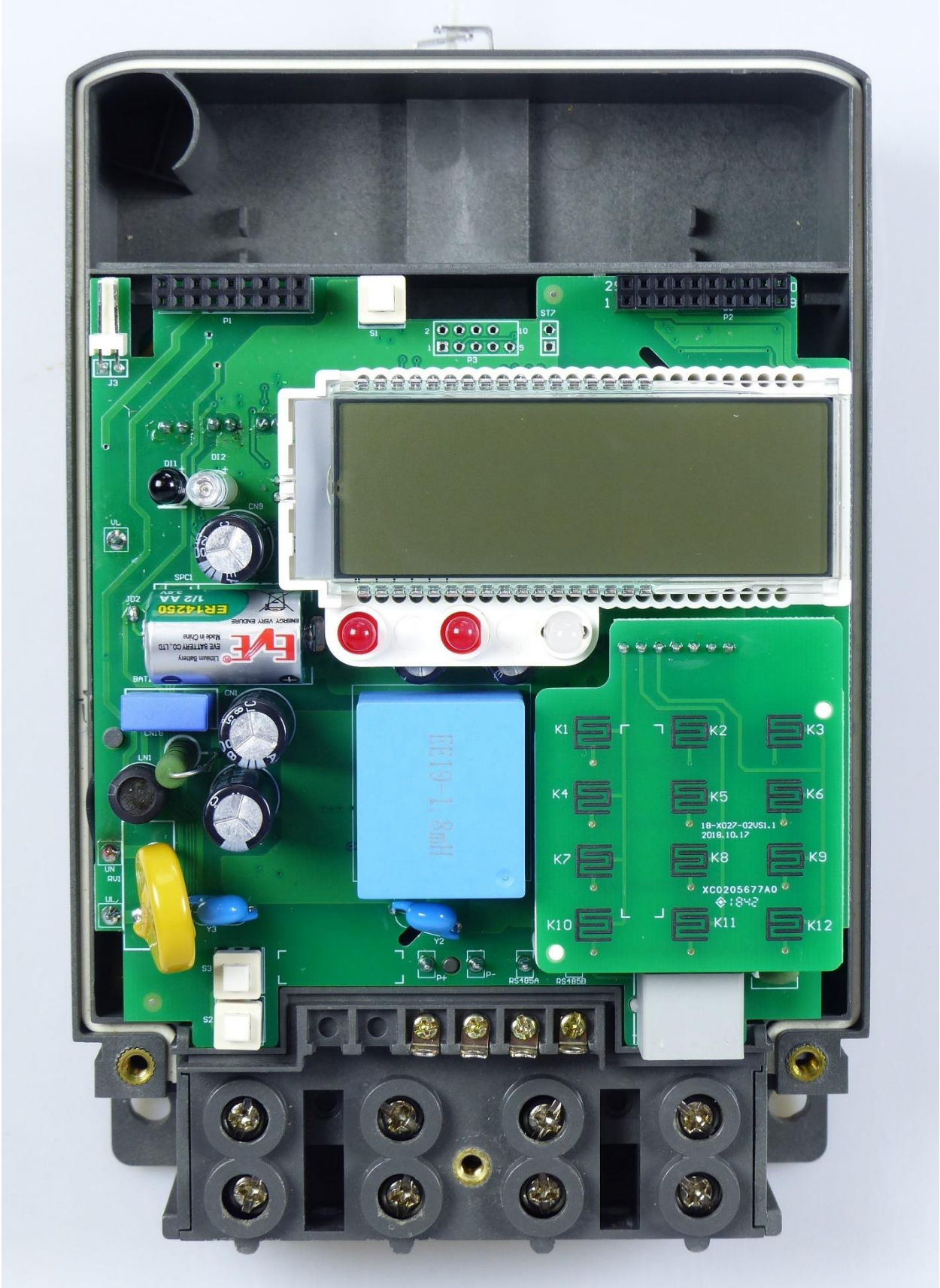



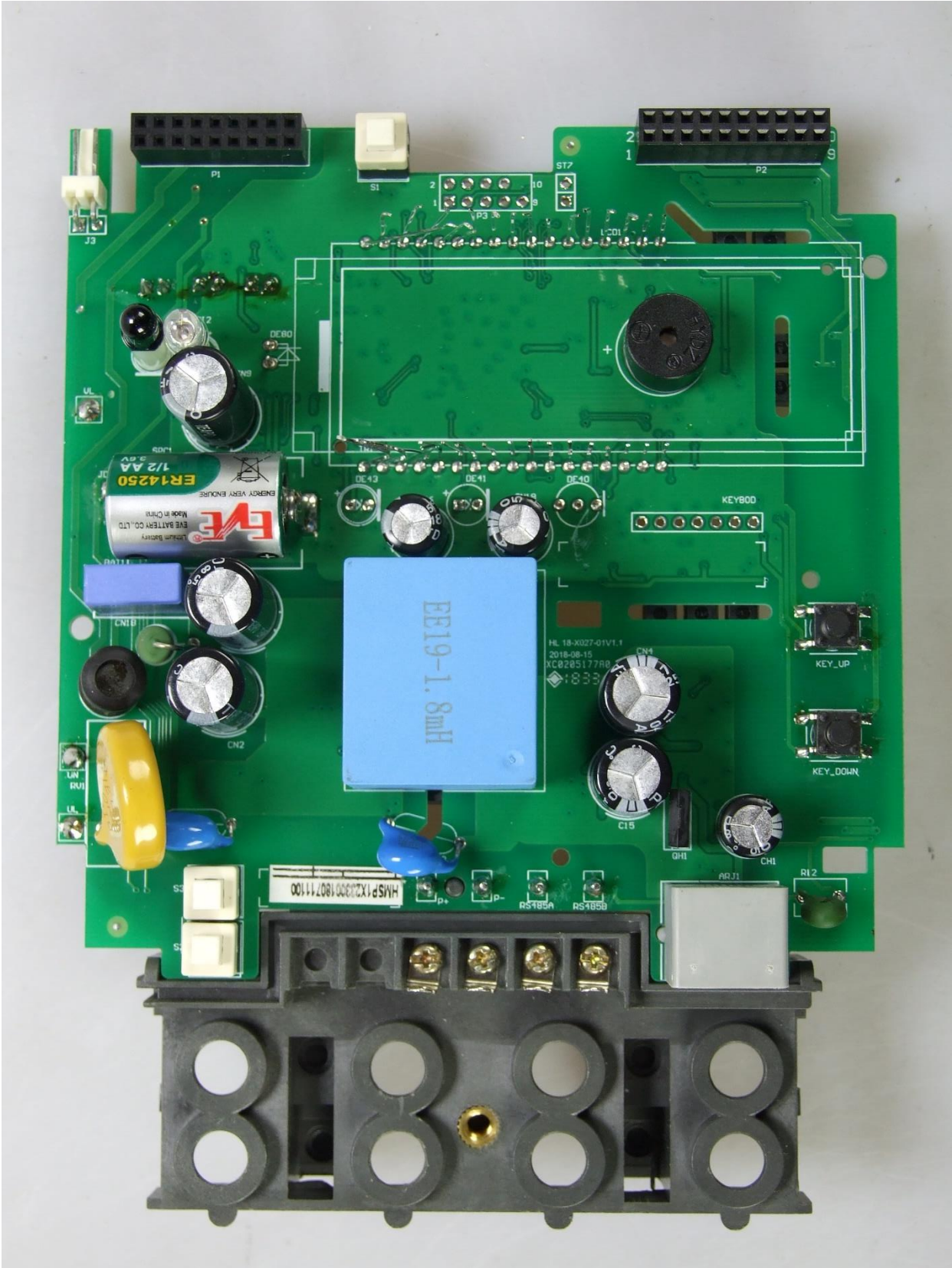

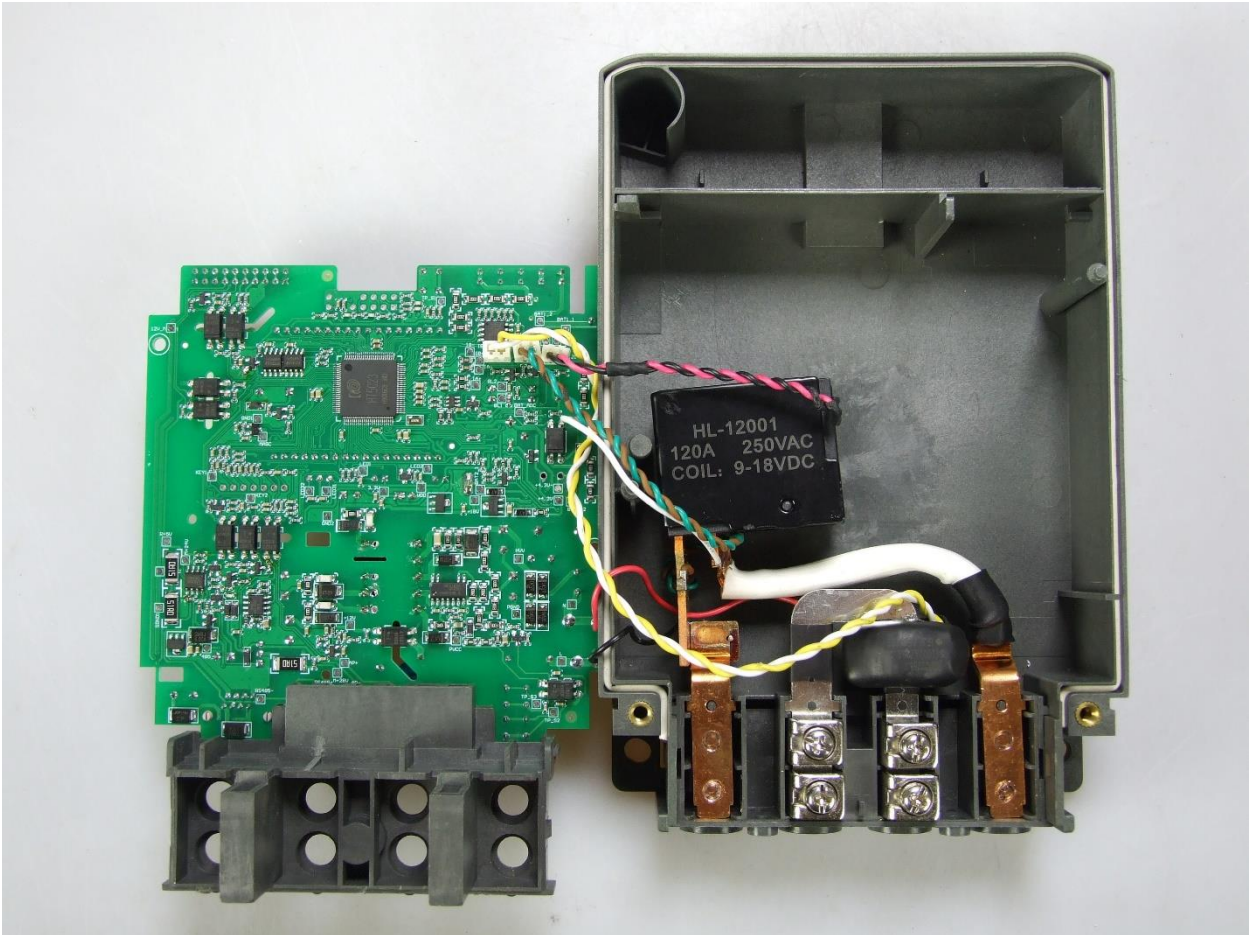

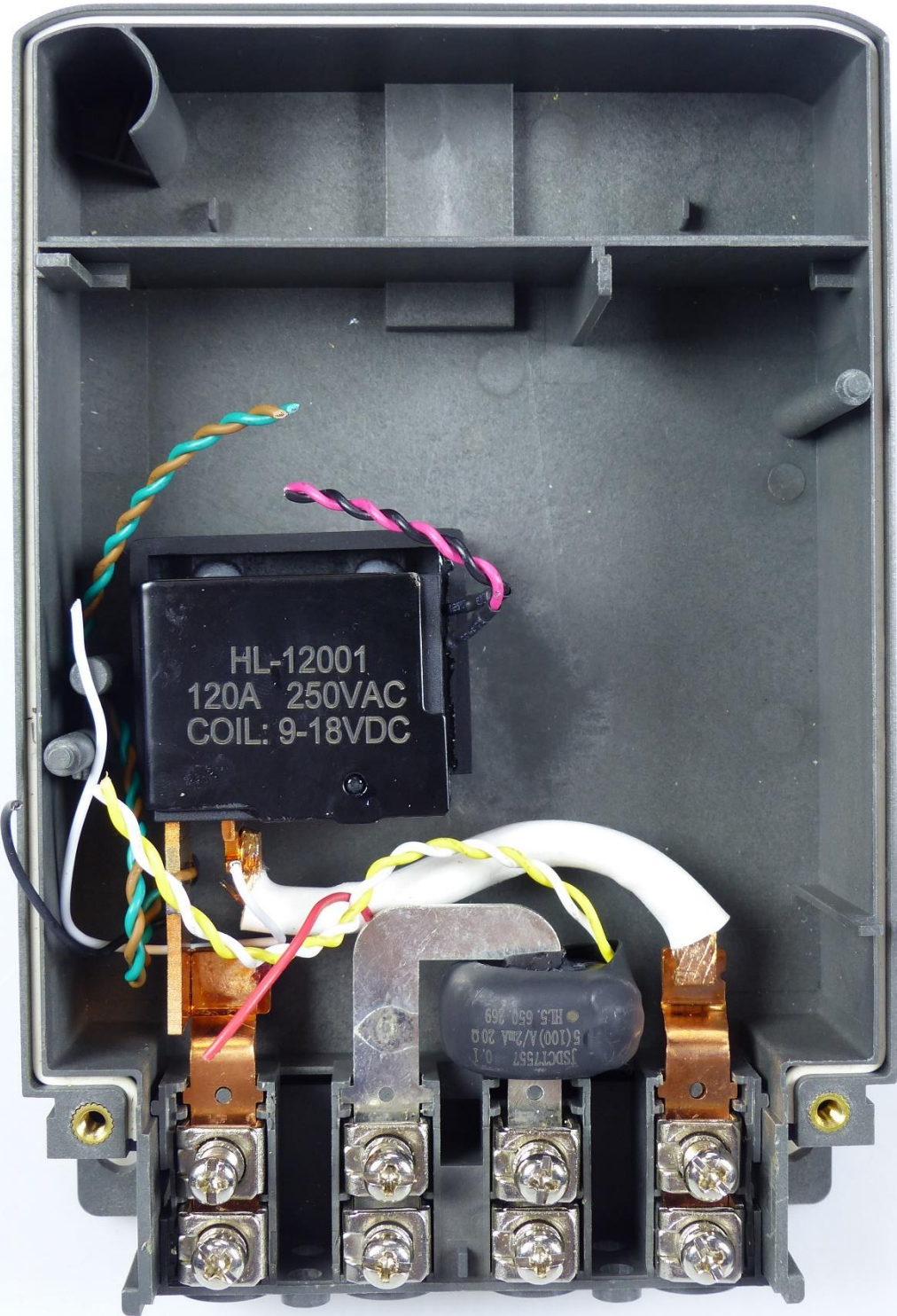

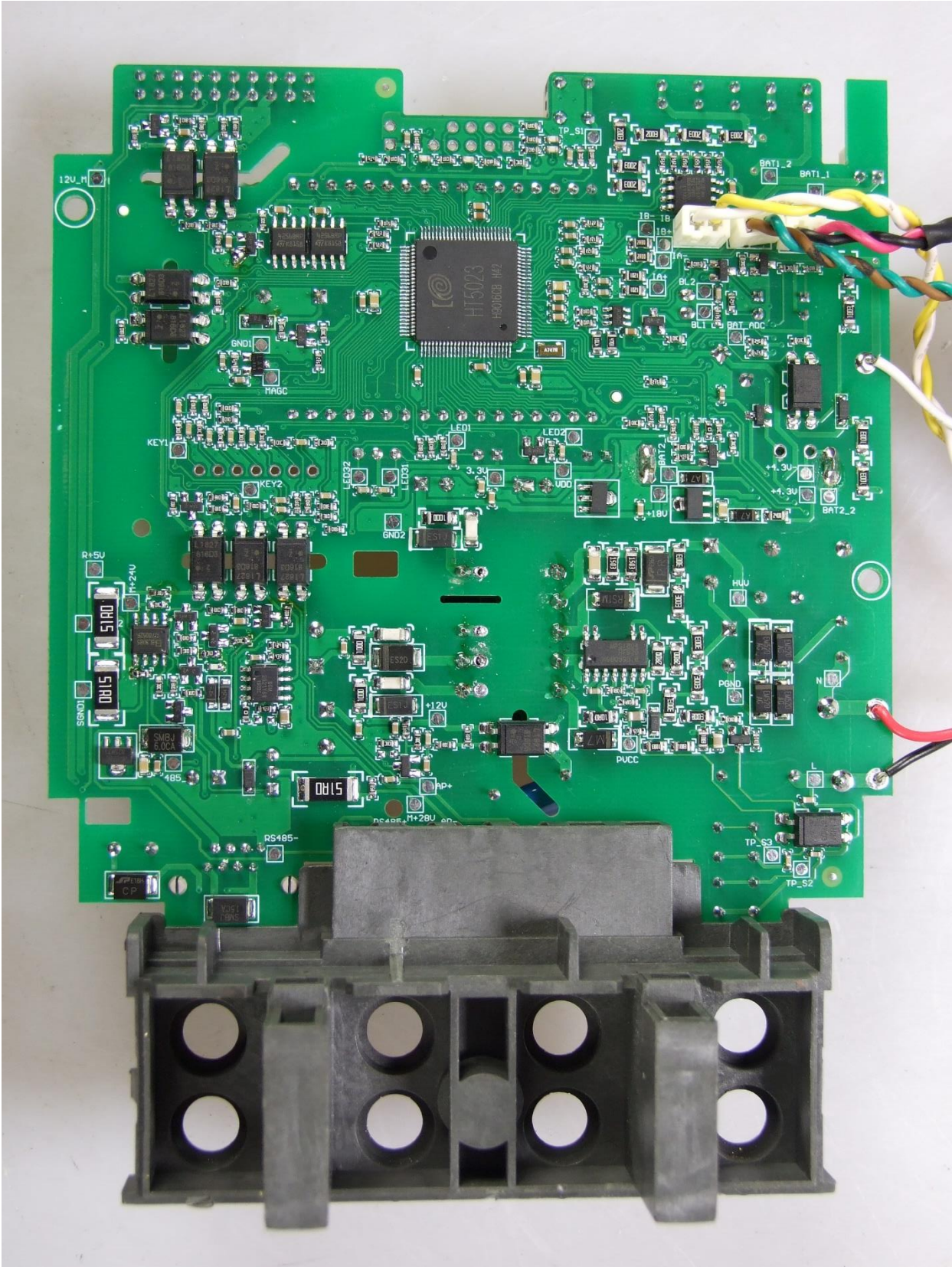

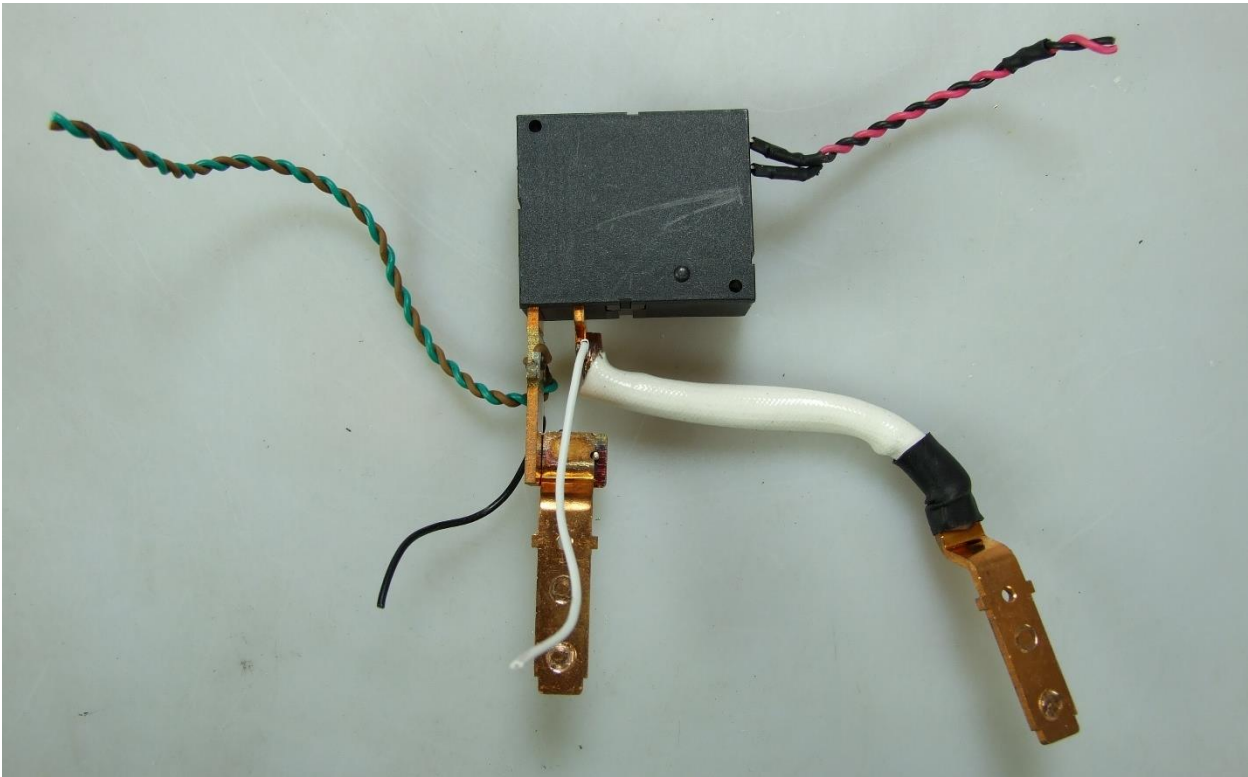
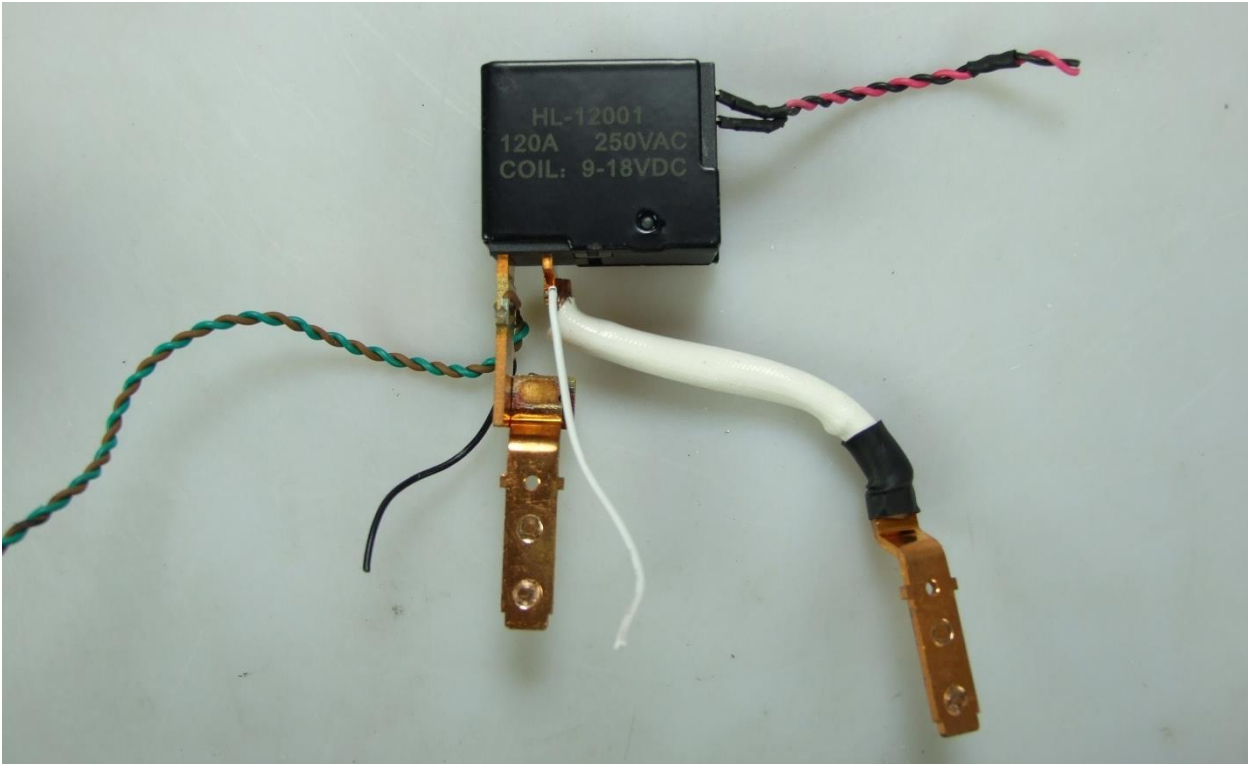

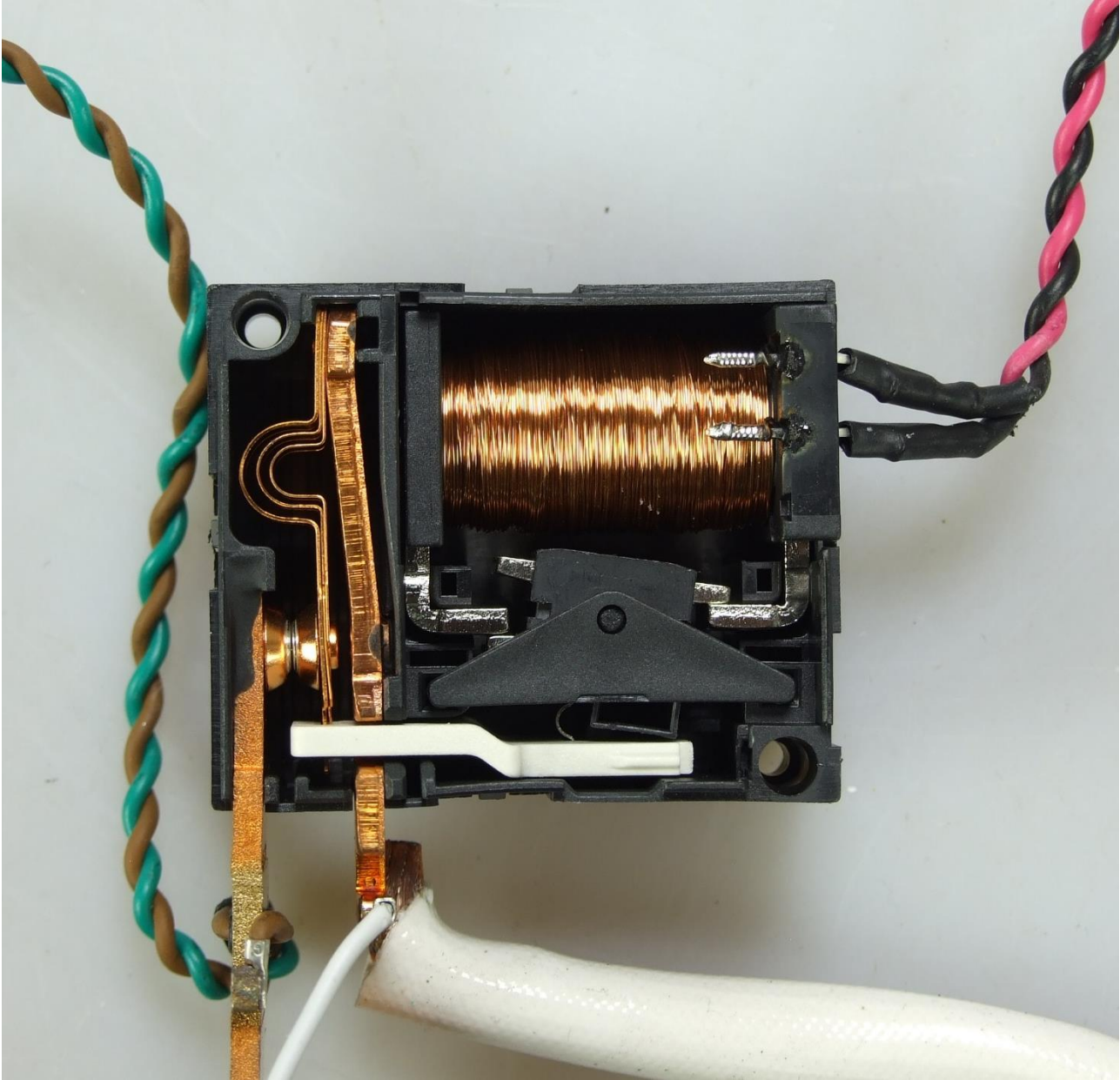

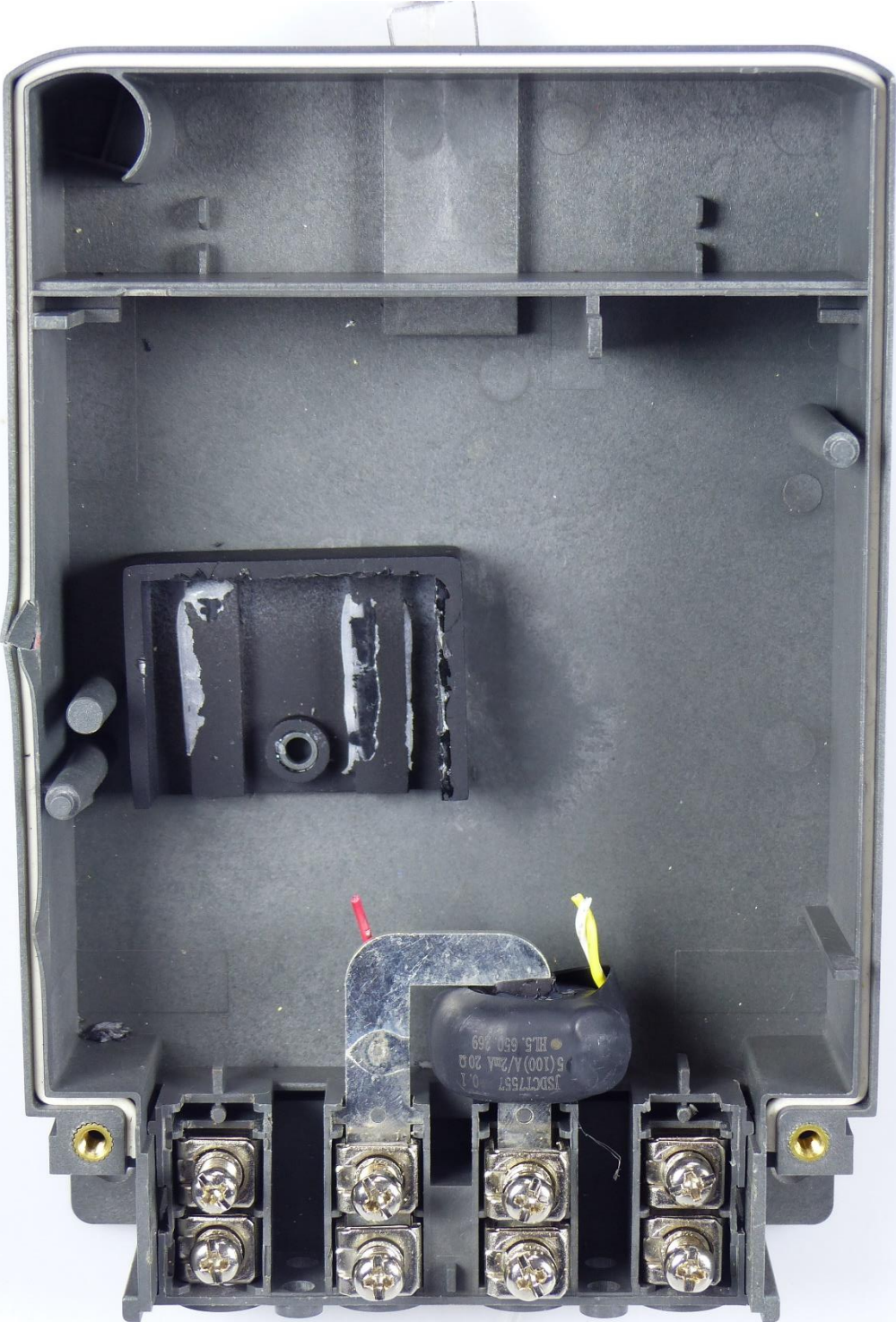

Appendix C Cross-reference table and checklist for static meters

Chapter	Test	IEC 62052-11 clause	IEC 62053-21 clause	EN 50470-1 clause	EN 50470-3 clause	Applied standards	
3	Marking of the meter	5.12		5.12		IEC 60387, IEC 60417-2, EN 62053-52	Pass
4.1	General- and mechanical requirements	5		5.1	5		Pass
4.1.3	Spring hammer test	5.2.2.1		5.2.2.1.		EN-IEC 60068-2-75	Pass
4.1.4	Shock test	5.2.2.2		5.2.2.2		EN-IEC 60068-2-27	Pass
4.1.5	Vibration test	5.2.2.3		5.2.2.3		EN-IEC 60068-2-6	Pass
4.1.6	Protection against penetration of dust and water	5.9		5.9		EN-IEC 60529	Pass
4.1.7	Terminal block material test	5.4		5.4		ISO 75-2	Pass
4.1.8	Resistance to heat and fire	5.8		5.8		EN-IEC 60695-2-11	Pass
4.2.2	Dry heat test	6.3.1		6.3.2.		EN-IEC 60068-2-2	Pass
4.2.3	Cold test	6.3.2		6.3.3.		EN-IEC 60068-2-1	Pass
4.2.4	Damp heat cyclic test	6.3.3		6.3.4.		EN-IEC 60068-2-30	Pass
4.2.5	Solar radiation test	6.3.4		6.3.5.		EN-IEC 60068-2-5	N.A.
4.3	Accuracy measurement at different loads		8.1		8.1		Pass
4.3.1	Interpretation of test results		8.6		8.7.3.		Pass
4.3.2	Meter constant		8.4		8.7.10		Pass
4.3.3	Starting current		8.3		8.7.9.4.		Pass
4.3.4	Test of no load condition		8.3		8.7.9.3.		Pass
4.4.1	Influence of ambient temperature variation		8.2		8.7.5.2.		Pass
4.4.2	Auxiliary voltage variation		8.2				N.A.
4.4.3	Voltage variation		8.2		8.7.5.3.		Pass
4.4.4	Frequency variation		8.2		8.7.5.4		Pass
4.4.5	Magnetic induction of external origin 0,5 mT		8.2		8.7.7.11	EN-IEC 61000-4-8	Pass
4.4.6	Harmonic components		8.2		8.7.7.7.		Pass
4.4.7	D.C. and even harmonics		8.2		8.7.7.8.		Pass
4.4.8	Odd harmonics in the a.c. current circuit		8.2		8.7.7.9		Pass
4.4.9	Sub-harmonics in the a.c. current circuit		8.2		8.7.7.9.		Pass
4.4.10	Reversed phase sequence		8.2		8.7.7.3.		N.A.
4.4.11	Voltage unbalance		8.2		8.7.7.4.		N.A.
4.4.12	Continuous magnetic induction of external origin		8.2	7.4.11	8.7.7.10		Pass
4.4.13	Operation of accessories		8.2		8.7.7.13		Pass
4.4.14	Immunity to earth fault	7.4			8.7.7.6.		N.A.

Chapter	Test	IEC 62052-11 clause	IEC 62053-21 clause	EN 50470-1 clause	EN 50470-3 clause	Applied standards	
4.5	Influence of short-time overcurrents		7.2		8.7.8		Pass
4.6.1	Influence of self heating		7.3		8.7.7.5.		Pass
4.6.2	Heating	7.2		7.2.			Pass
4.7	Power consumption		7.1		7.1		Pass
4.8	Fast transient burst test	7.5.4		7.4.7	8.7.7.14	EN-IEC 61000-4-4	Pass
4.9	Electrostatic discharges	7.5.2		7.4.5.		EN-IEC 61000-4-2	Pass
4.10	Immunity to electromagnetic RF fields	7.5.3		7.4.6.	8.7.7.12	EN-IEC 61000-4-20	Pass
4.11	Immunity to RF conducted disturbances	7.5.5		7.4.8.	8.7.7.15	EN-IEC 61000-4-6	Pass
4.12	Radio interference suppression	7.5.8		7.4.13		CISPR 22, EN 55022	Pass
4.13	Voltage dips and short interruptions	7.1.2		7.4.4.		EN-IEC 61000-4-11	Pass
4.14	Surge immunity test	7.5.6		7.4.9.		EN-IEC 61000-4-5	Pass
4.15	Damped oscillatory waves immunity test	7.5.7		7.4.10	8.7.7.16	EN-IEC 61000-4-12	N.A.
4.16.1	Impulse voltage test	7.3.2		7.3.3.		IEC 60060-1	Pass
4.16.2	A.C. voltage test	7.3.3			7.2.		Pass
5	Maximum Permissible Error				8.7.6		Pass
6	Durability				9		Pass
6	Reliability				10		Pass
7	Software and protection against corruption				11		Pass

Chapter	Test	IEC 62055-31 clause	Applied standards	
4.1.6	Protection against penetration of dust and water	5.10	EN-IEC 60529	Pass
4.1.8	Resistance to heat and fire	5.9	EN-IEC 60695-2-11	Pass
4.1.9	Display, Register and output device	5.11 and 5.13		Pass
4.1.10	Token carrier acceptor	5.14.2		N/A
4.1.10	Keypad interface	5.14.3		Pass
4.2.2	Dry heat test - Storage and transport	6.4.2		Pass
4.2.6	Crystal-controlled clocks on a.c. supplies	Annex D 4.3.1		Pass
4.2.7	Crystal-controlled clocks on operation reserve	Annex D 4.3.2		Pass
4.2.8	Accuracy of crystal-controlled clocks at temperature limits	Annex D 4.3.3		Pass
4.4.14	Severe voltage variations	Annex A 1.4		Pass
4.4.15	Abnormal voltage conditions	7.2.3		Pass
4.4.18	Core functional tests within the voltage and temperature range limits	Annex A 1.3		Pass
4.4.18	Operation within the limit range of operation with temperature	Annex A 1.5		Pass
4.4.16	3 th Harmonic component in the voltage circuit	Annex D 5.3		Pass
4.5	Influence of short-time overcurrents	7.4		Pass
4.7	Power consumption	7.3		Pass
4.8	Fast transient burst test	7.8.4 and annex D 5.1	EN-IEC 61000-4-4	Pass
4.9	Electrostatic discharges	7.8.2 and annex D 5.1	EN-IEC 61000-4-2	Pass
4.10	Immunity to electromagnetic RF fields	7.8.3 and annex D 5.1	EN-IEC 61000-4-3	Pass
4.11	Immunity to RF conducted disturbances	7.8.5 and annex D 5.1	EN-IEC 61000-4-6	Pass
4.13	Voltage dips and short interruptions	7.2.2 and annex D 5.2	EN-IEC 61000-4-11	Pass
4.14	Surge immunity test	7.8.6 and annex D 5.1	EN-IEC 61000-4-5	Pass
	Performance requirements UC1	7.9.3		N/A
9	Performance requirements UC3	7.9.4		Pass
8.1	Interruptions to token acceptance	Annex A 1.6.1		N/A
8.2	Token acceptance	Annex A 1.2.1		Pass
8.3	Rejection of duplicate tokens	Annex A 1.6.2		Pass
8.4	Rejection of valid tokens when available credit is saturated	Annex A 1.6.3		Pass
8.5	Energy register roll-over	Annex A 1.6.4		Pass

Appendix D Plots

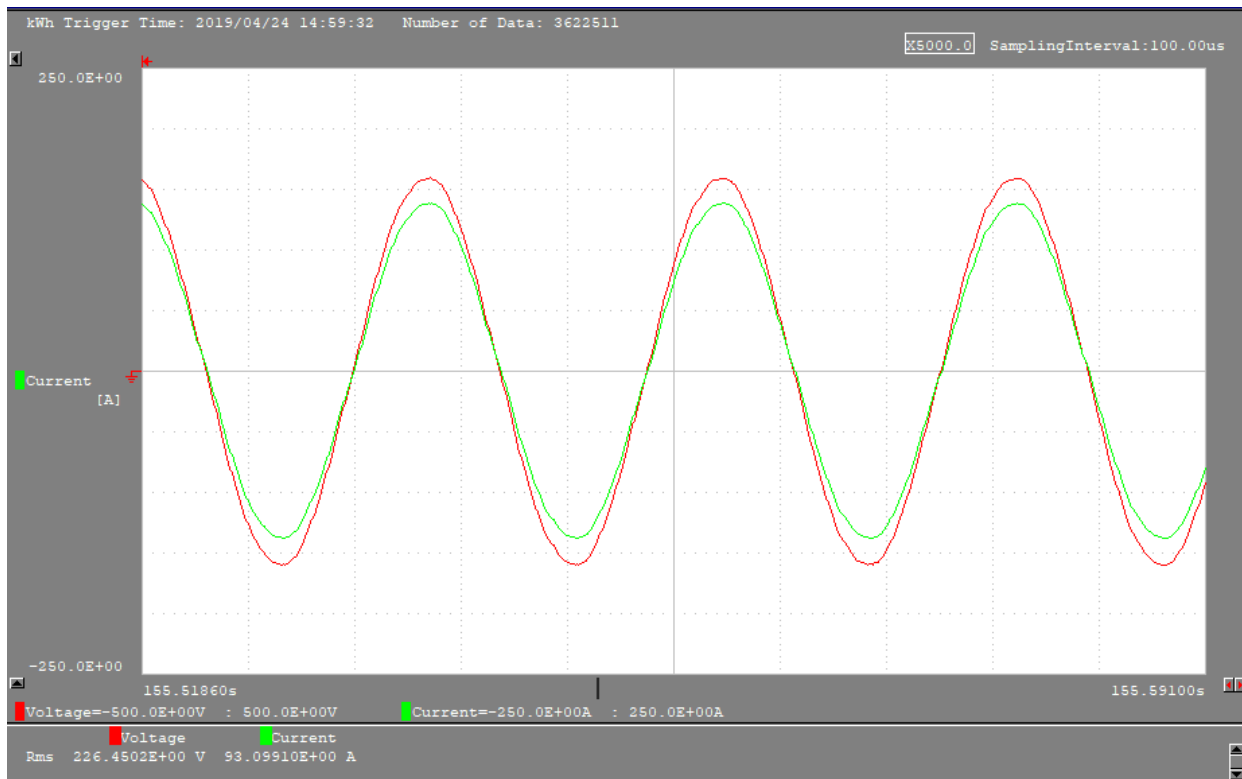

Figure 1: plot of first cycle from C3, to indicate electrical quantities at PF=1

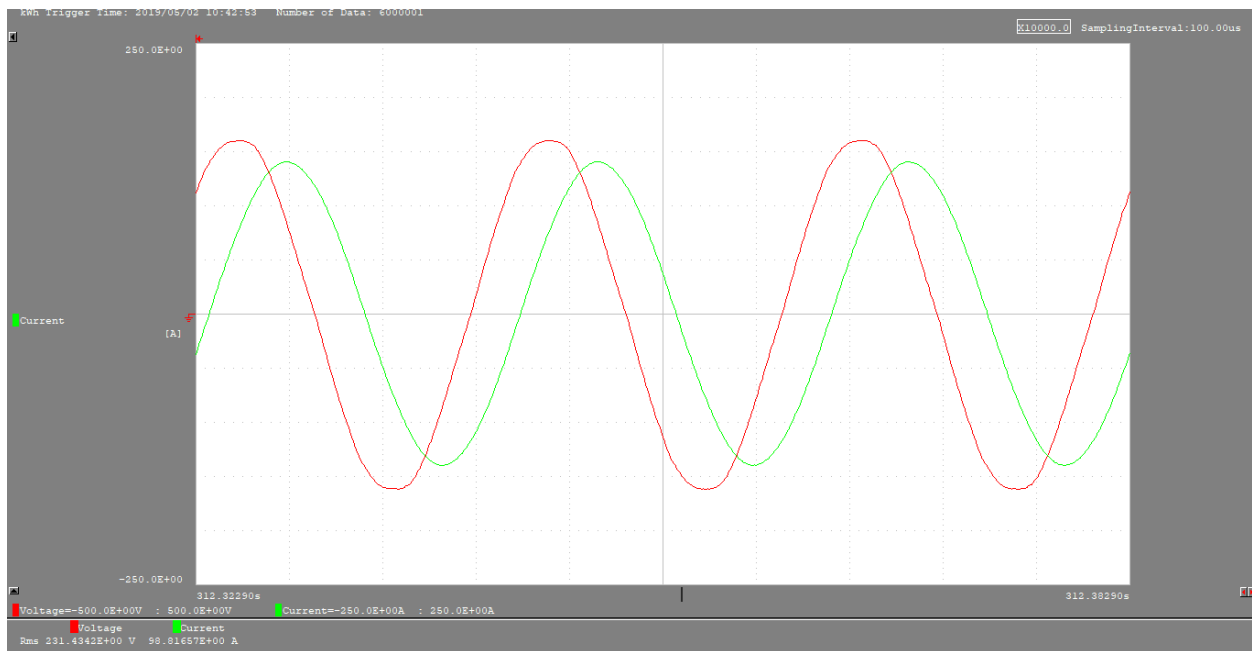

Figure 2: plot of first cycle from C3, to indicate electrical quantities at PF=0,5i

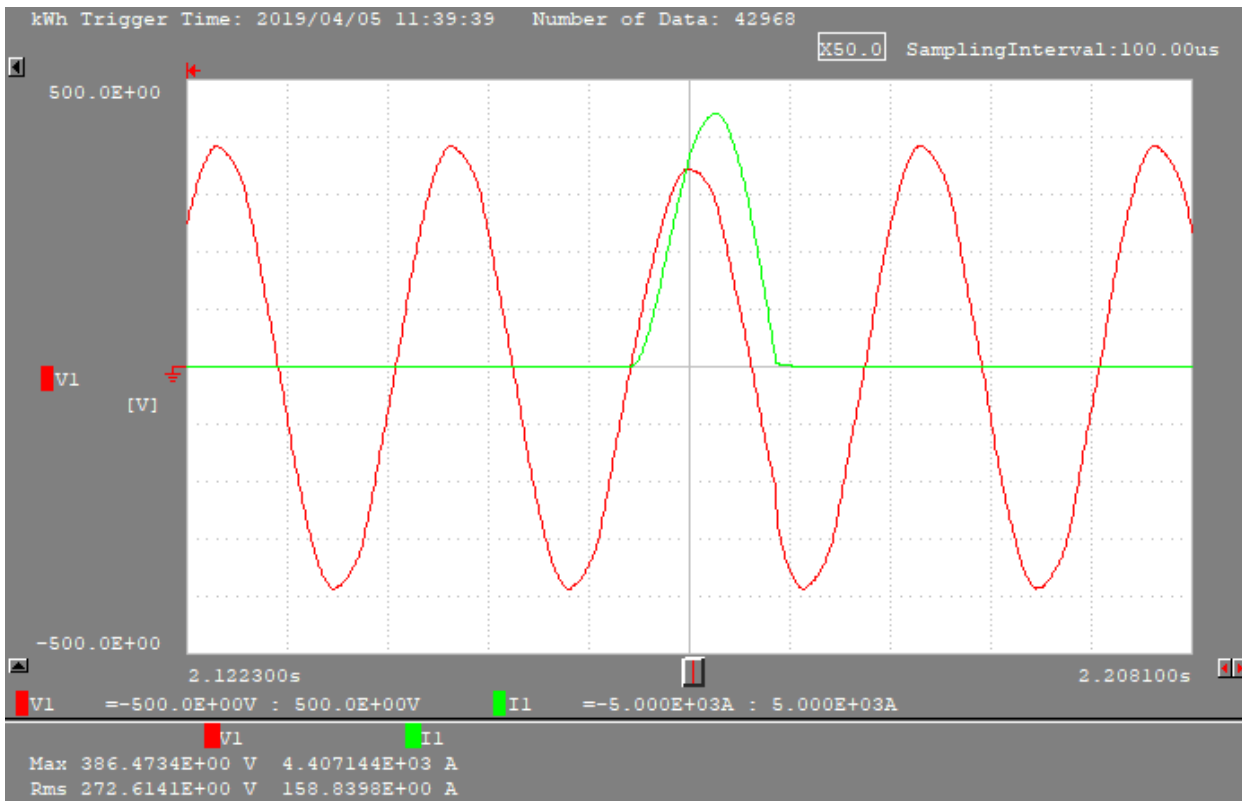

Figure 3: plot of measured initial test shot for C5, fault current making capacity

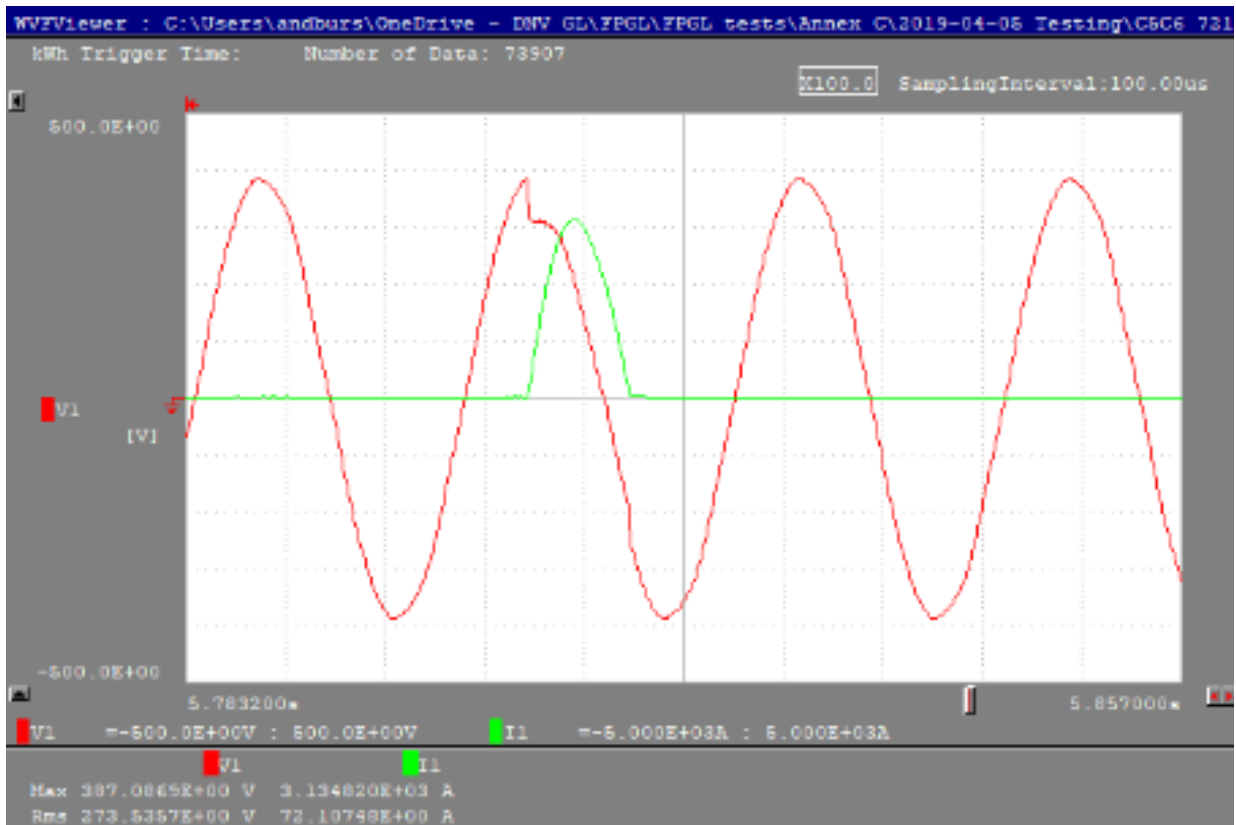

Figure 4: plot of measured test shot 1, for C5, fault current making capacity

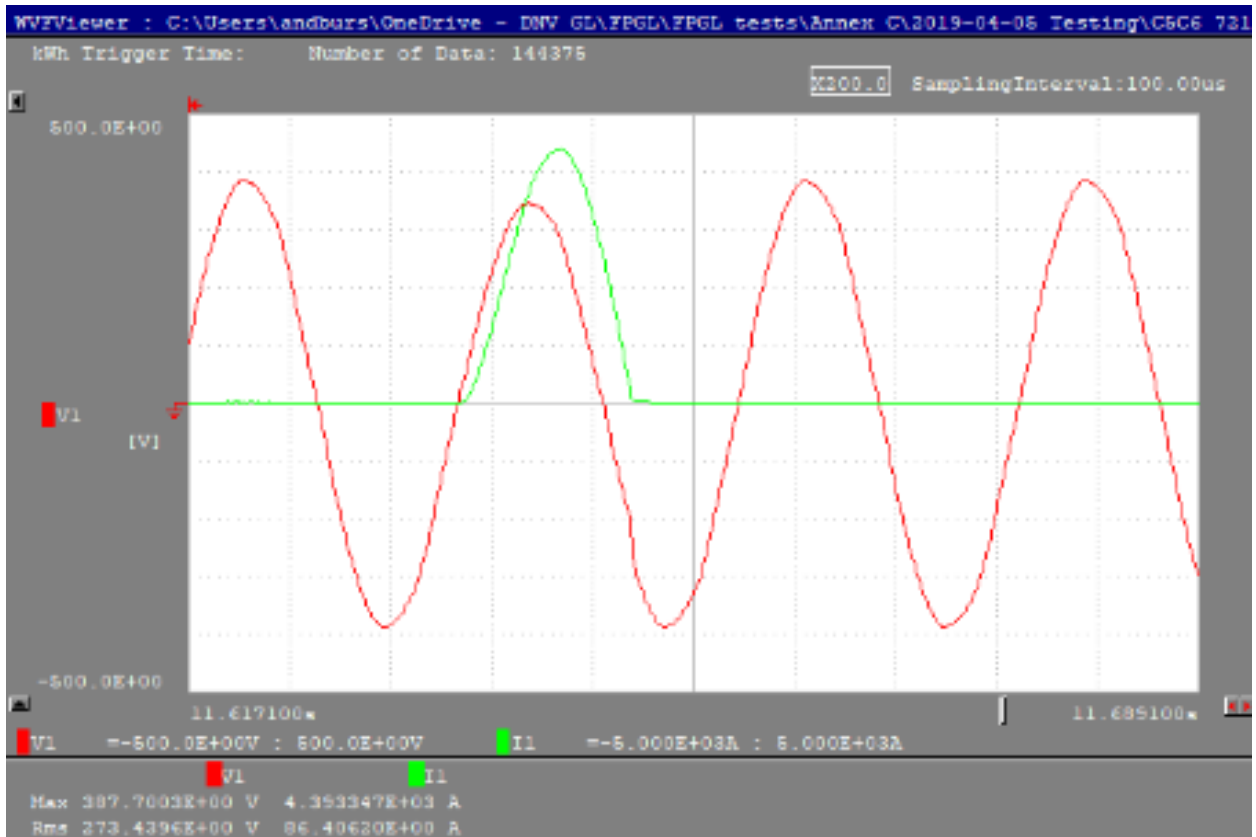

Figure 5: plot of measured test shot 2, for C5, fault current making capacity

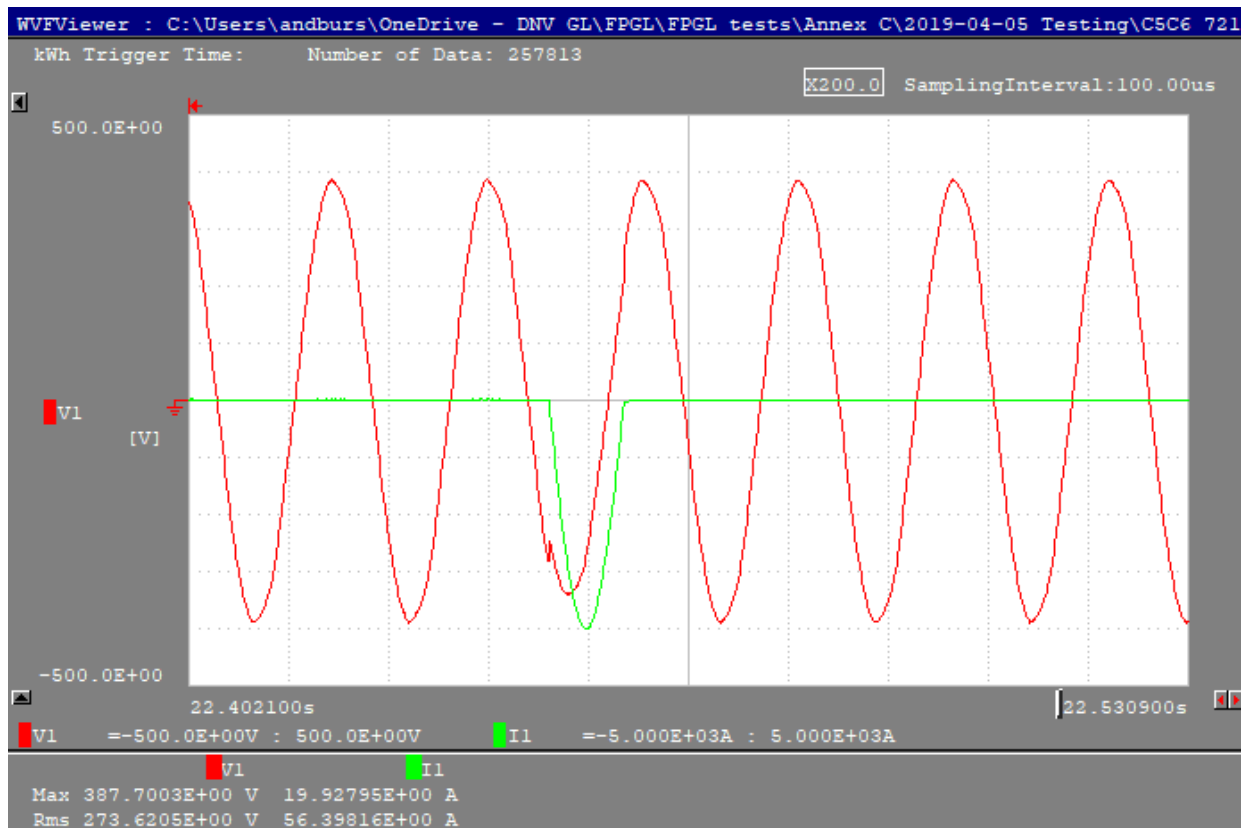

Figure 6: plot of measured test shot 3, for C5, fault current making capacity

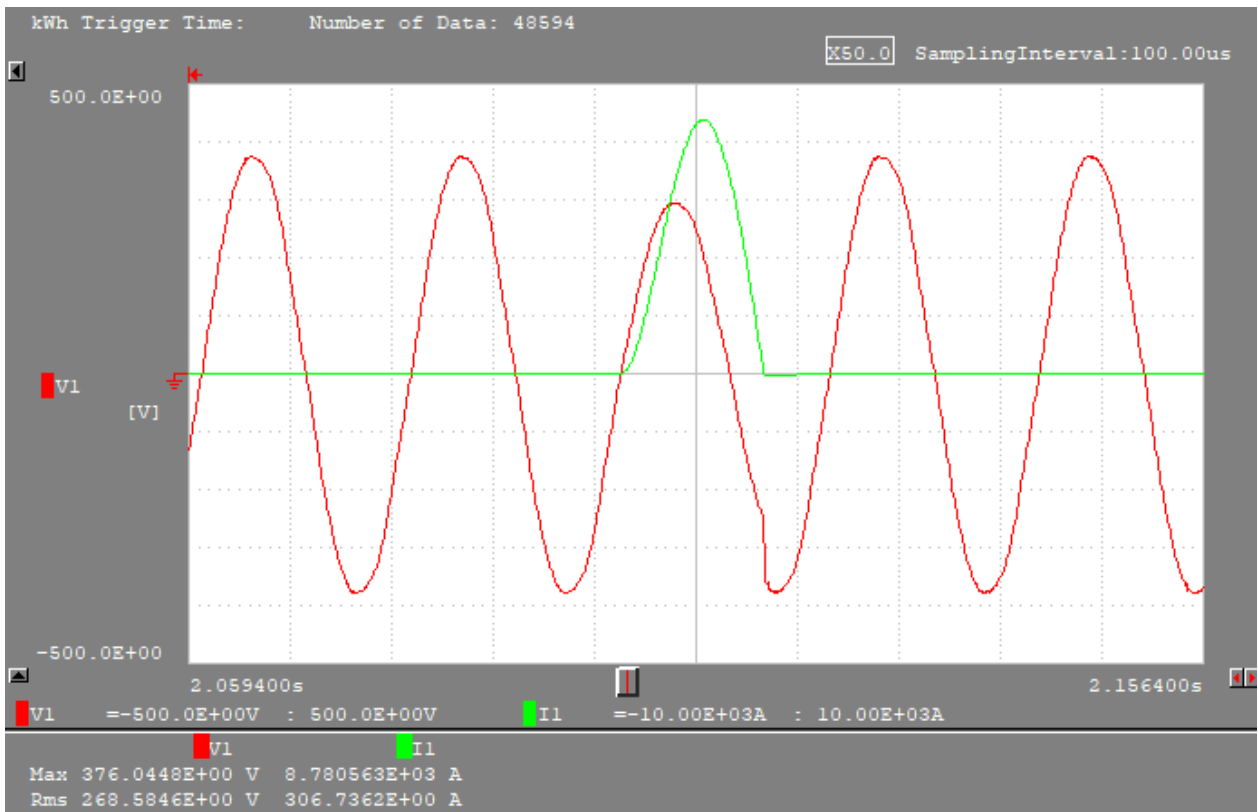

Figure 7 plot of measured initial test shot for C6 test 1, short-circuit current carrying capacity

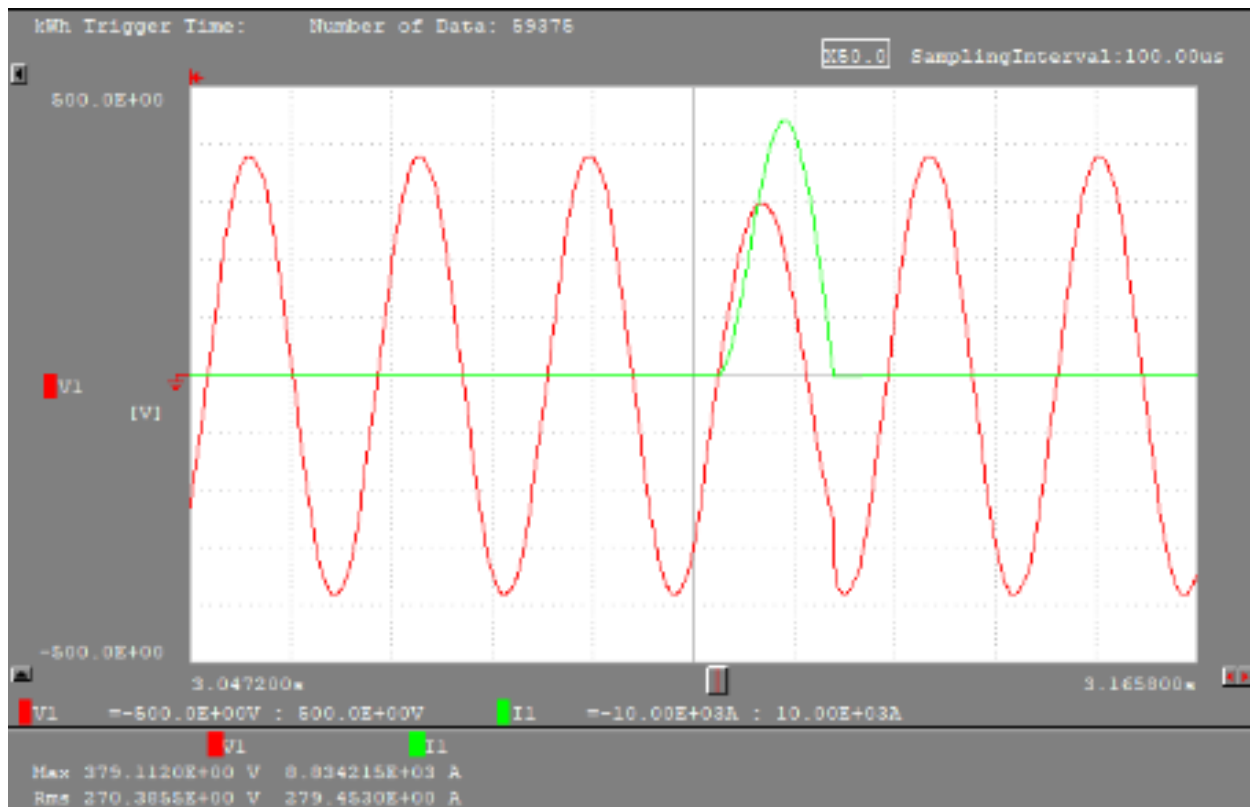

Figure 8: plot of measured test shot 1, for C6 test 1, short-circuit current carrying capacity

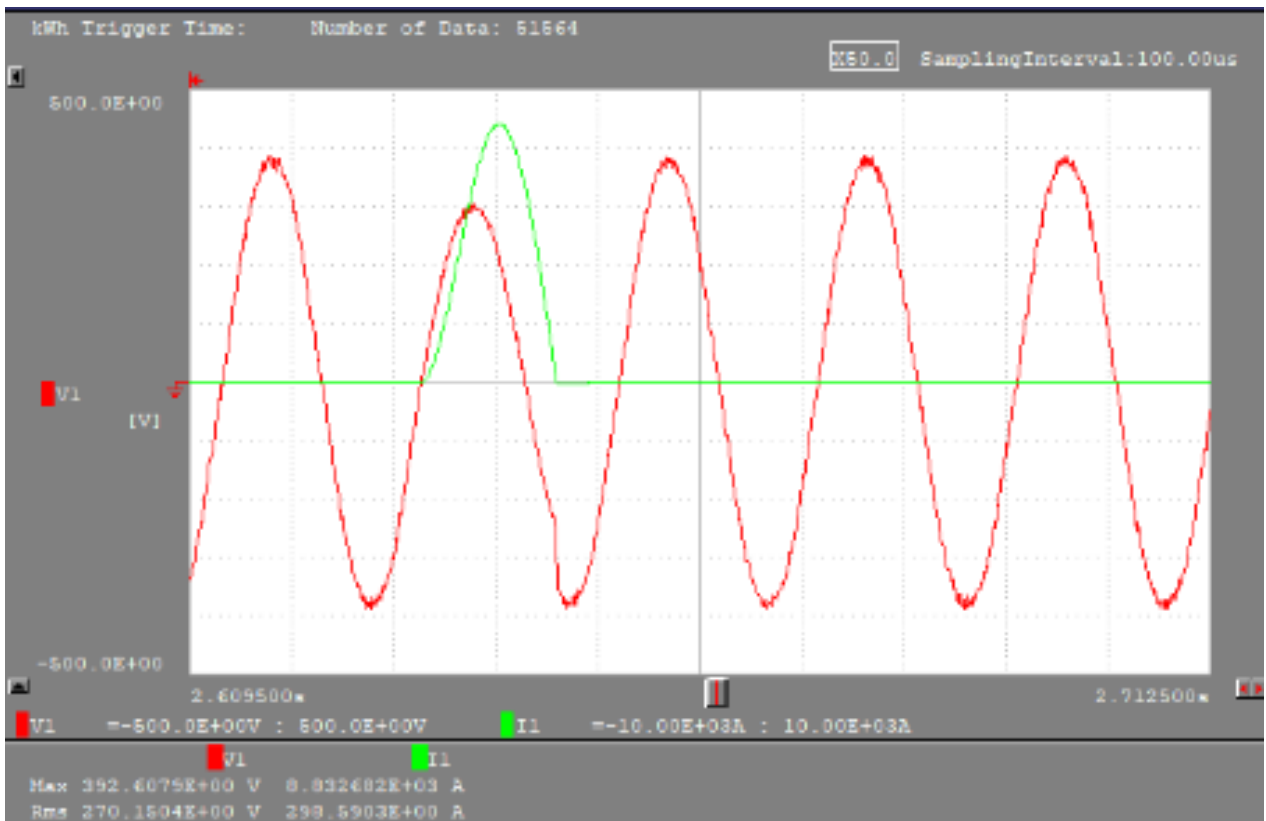

Figure 9: plot of measured test shot 2, for C6 test 1, short-circuit current carrying capacity

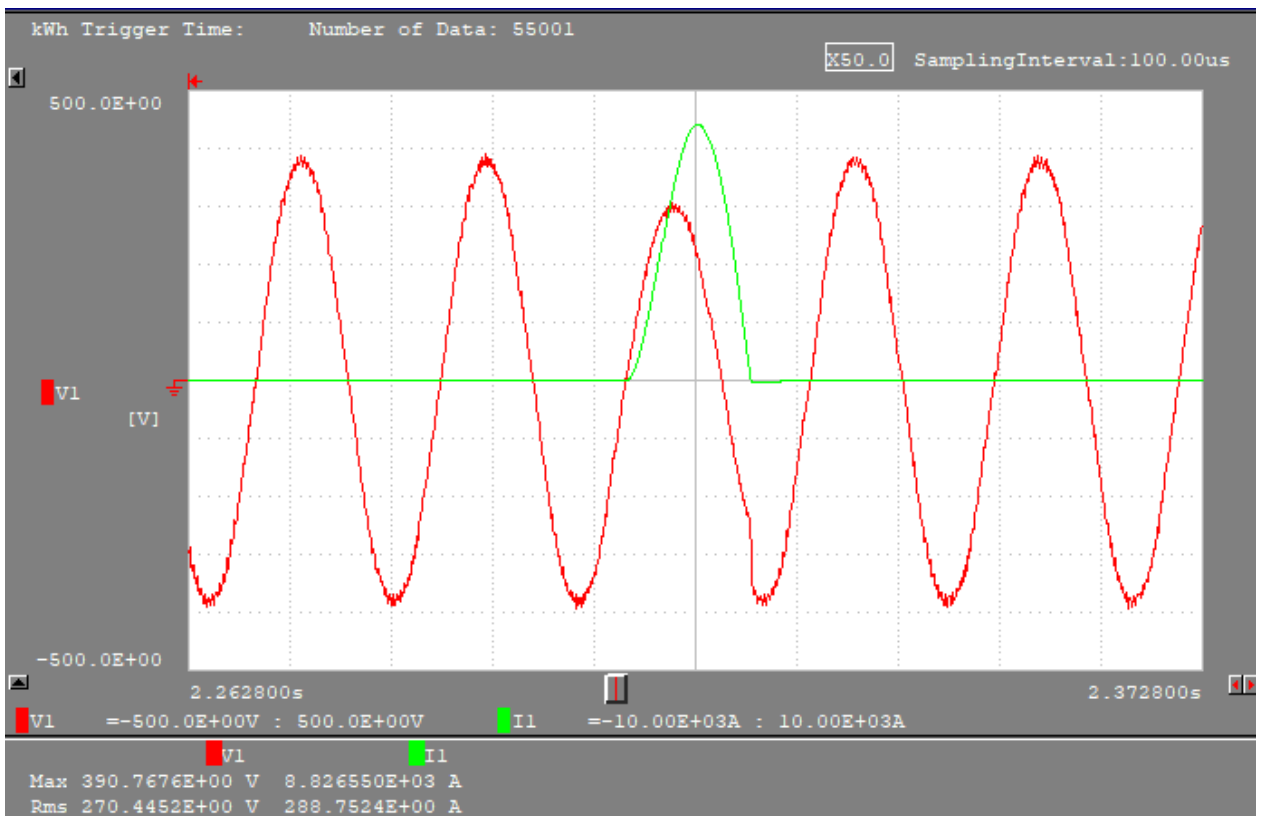

Figure 10: plot of measured test shot 3, for C6 test 1, short-circuit current carrying capacity

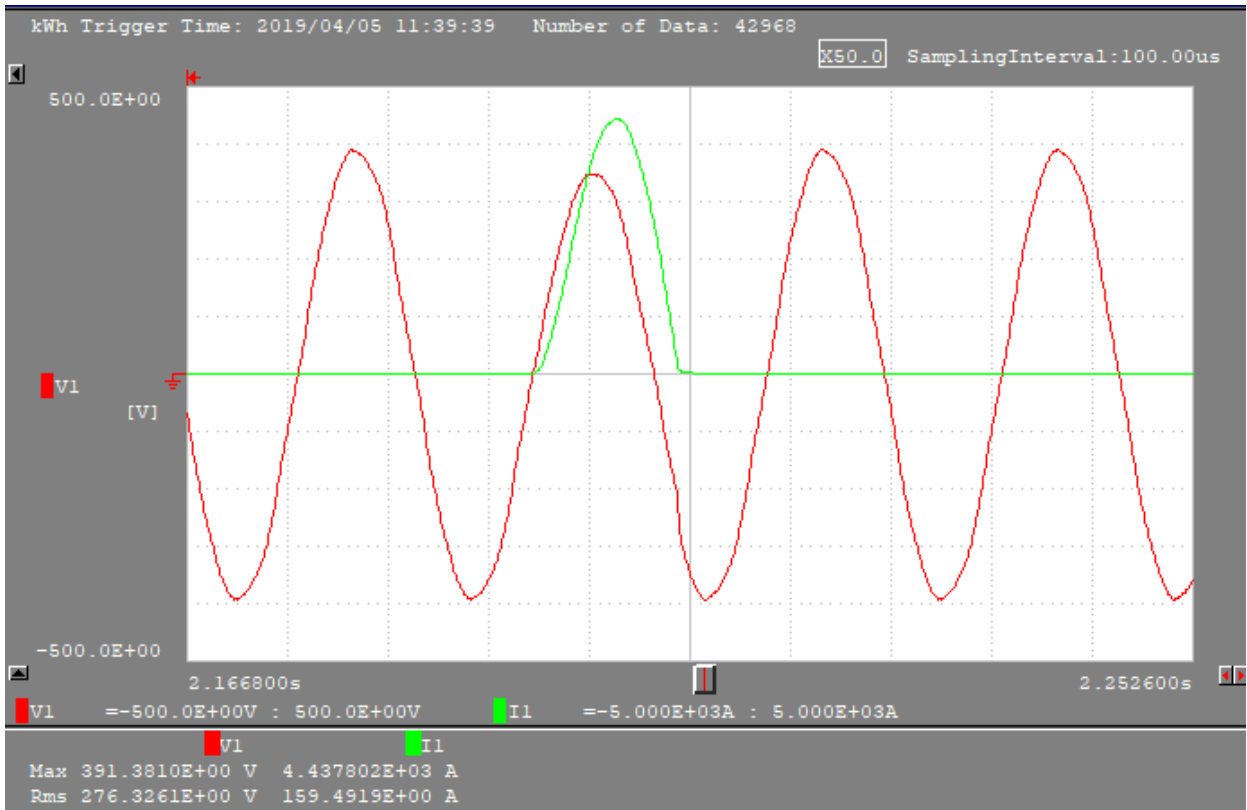

Figure 11: plot of measured initial test shot for C6 test 2, short-circuit current carrying capacity

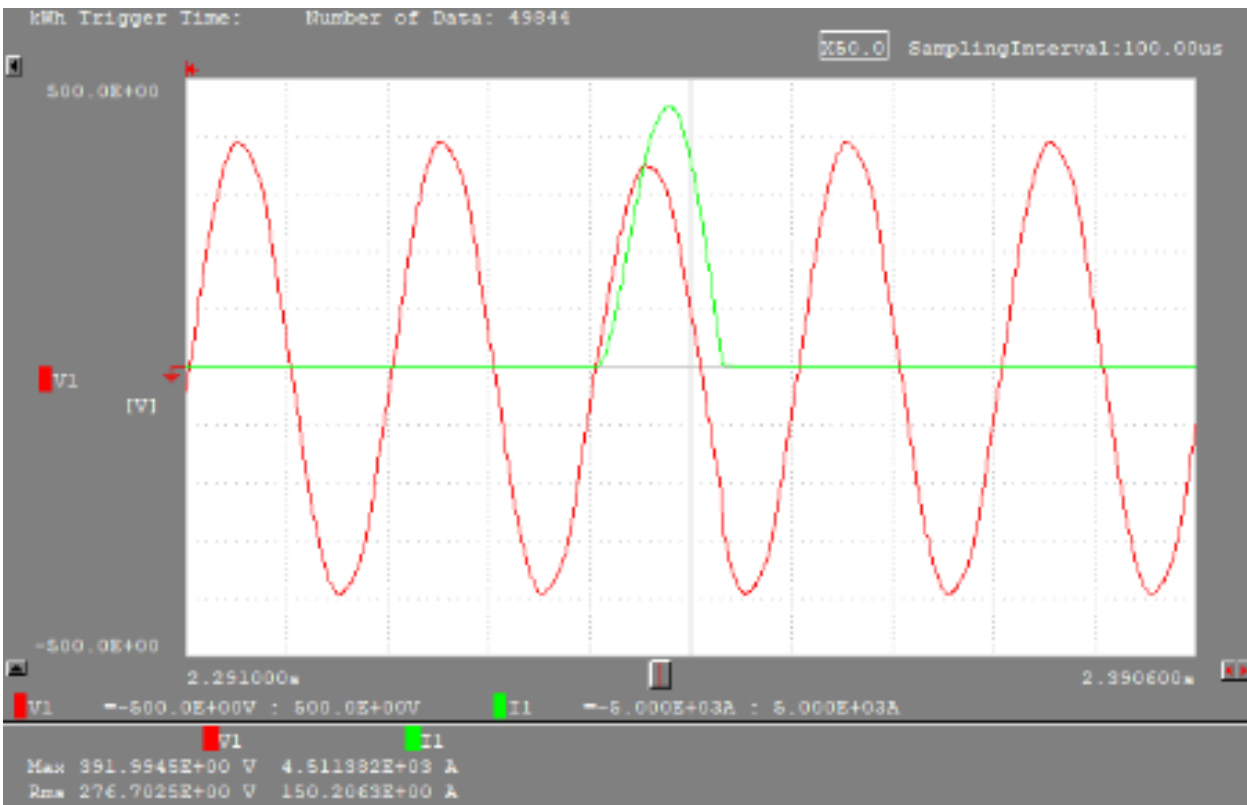

Figure 12: plot of measured test shot 1, for C6 test 2, short-circuit current carrying capacity

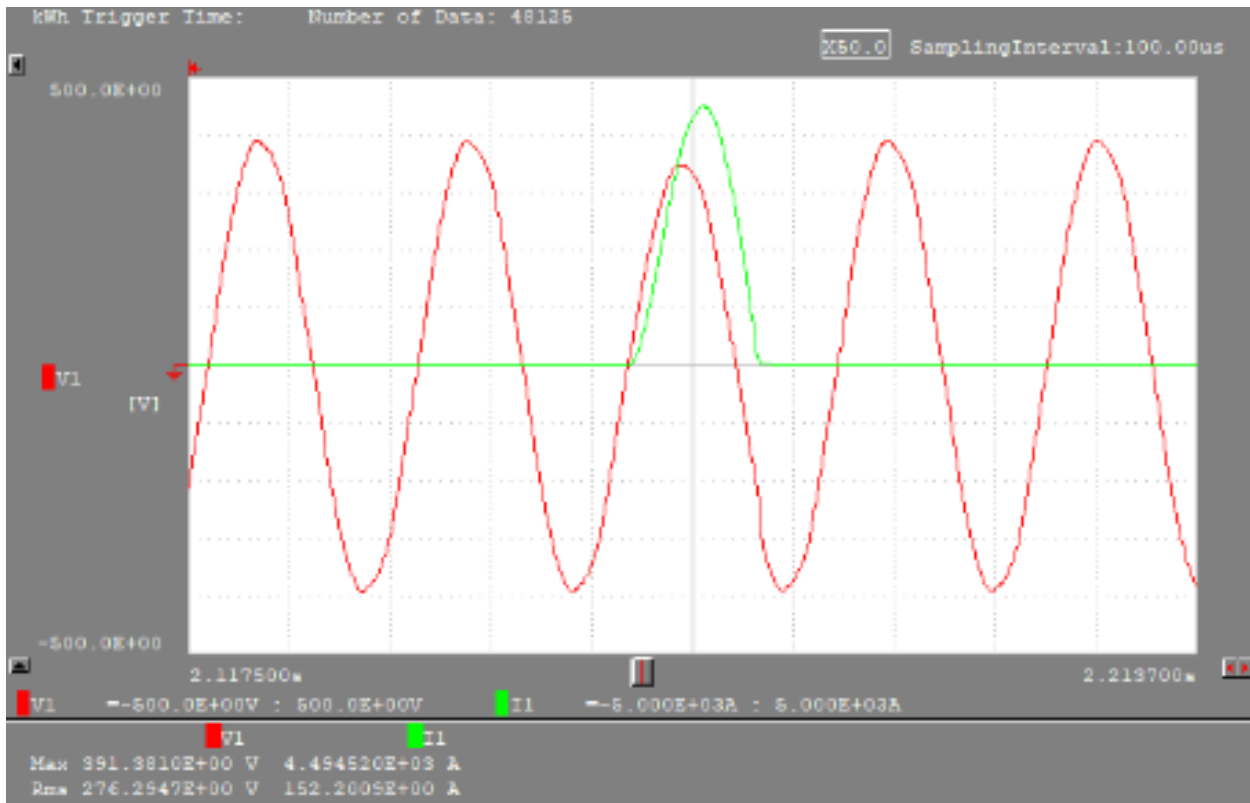

Figure 13: plot of measured test shot 2, for C6 test 2, short-circuit current carrying capacity

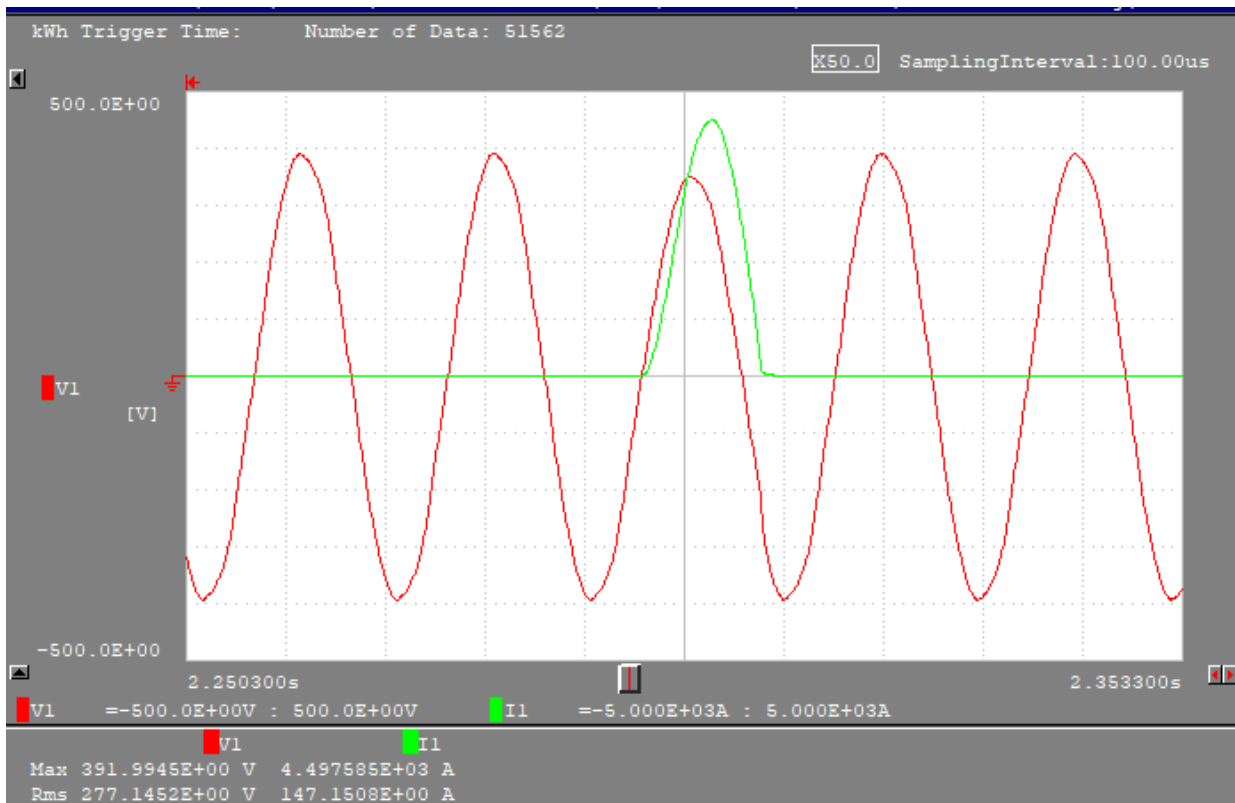

Figure 14: plot of measured test shot 3, for C6 test 2, short-circuit current carrying capacity

Appendix E Checklist for Measuring Instrument Directive MID 2014/32/EU

Annex I, Essential Requirements

1	Allowable Errors	§	
1.1	Under rated operating conditions and in the absence of a disturbance, the error of measurement shall not exceed the maximum permissible error (MPE) value as laid down in the appropriate instrument-specific requirements. Unless stated otherwise in the instrument-specific annexes, MPE is expressed as a bilateral value of the deviation from the true measurement value.		Pass
1.2	Under rated operating conditions and in the presence of a disturbance, the performance requirement shall be as laid down in the appropriate instrument-specific requirements. Where the instrument is intended to be used in a specified permanent continuous electromagnetic field the permitted performance during the radiated electromagnetic field-amplitude modulated test shall be within MPE.		Pass
1.3	The manufacturer shall specify the climatic, mechanical and electromagnetic environments in which the instrument is intended to be used, power supply and other influence quantities likely to affect its accuracy, taking account of the requirements laid down in the appropriate instrument-specific annexes.	See chapter 3	Pass
1.3.1	Climatic environments The manufacturer shall specify the upper temperature limit and the lower temperature limit from any of the values in Table 1 unless otherwise specified in the Annexes III to XII, and indicate whether the instrument is designed for condensing or non-condensing humidity as well as the intended location for the instrument, i.e. open or closed.	See chapter 3. Condensing	Pass
1.3.2	(a) Mechanical environments are classified into classes M1 to M3. (b) The following influence quantities shall be considered in relation with mechanical environments: <ul style="list-style-type: none"> • vibration; • mechanical shock. 	See chapter 3 and 4.1	Pass
1.3.3	(a) Electromagnetic environments are classified into classes E1, E2 or E3, unless otherwise laid down in the appropriate instrument-specific annexes.	See chapter 3	Pass
1.3.3	(b) The following influence quantities shall be considered in relation with electromagnetic environments: <ul style="list-style-type: none"> • voltage interruptions; • short voltage reductions; • voltage transients on supply lines and/or signal lines; • electrostatic discharges; EN 29.3.2014 Official Journal of the European Union L 96/171 • radio frequency electromagnetic fields; • conducted radio frequency electromagnetic fields on supply lines and/or signal lines; 	See chapter 4	Pass

	<ul style="list-style-type: none"> surges on supply lines and/or signal lines. 		
1.3.4	<p>Other influence quantities to be considered, where appropriate, are:</p> <ul style="list-style-type: none"> voltage variation; mains frequency variation; power frequency magnetic fields; any other quantity likely to influence in a significant way the accuracy of the instrument. 	See chapter 4	Pass
1.4.1	<p>Basic rules for testing and the determination of errors</p> <p>Essential requirements specified in points 1.1 and 1.2 shall be verified for each relevant influence quantity. Unless otherwise specified in the appropriate instrument-specific annex, these essential requirements apply when each influence quantity is applied and its effect evaluated separately, all other influence quantities being kept relatively constant at their reference value.</p> <p>Metrological tests shall be carried out during or after the application of the influence quantity, whichever condition corresponds to the normal operational status of the instrument when that influence quantity is likely to occur.</p>	See chapter 4	Pass
1.4.2	<p>Ambient humidity</p> <p>(a) According to the climatic operating environment in which the instrument is intended to be used either the damp heat-steady state (non-condensing) or damp heat cyclic (condensing) test may be appropriate.</p> <p>(b) The damp heat cyclic test is appropriate where condensation is important or when penetration of vapour will be accelerated by the effect of breathing. In conditions where non-condensing humidity is a factor the damp- heat steady state is appropriate.</p>	See § 4.2	Pass
2	<p>Reproducibility</p> <p>The application of the same measurand in a different location or by a different user, all other conditions being the same, shall result in the close agreement of successive measurements. The difference between the measurement results shall be small when compared with the MPE.</p>		Pass
3	<p>Repeatability</p> <p>The application of the same measurand under the same conditions of measurement shall result in the close agreement of successive measurements. The difference between the measurement results shall be small when compared with the MPE.</p>		Pass
4	<p>Discrimination and Sensitivity</p> <p>A measuring instrument shall be sufficiently sensitive and the discrimination threshold shall be sufficiently low for the intended measurement task.</p>		Pass
5	<p>Durability</p> <p>A measuring instrument shall be designed to maintain an adequate stability of its metrological characteristics over a period of time estimated by the manufacturer, provided that it is properly installed, maintained and used according to the manufacturer's instruction when in the environmental conditions for which it is intended.</p>	See chapter 6	Pass
6	<p>Reliability</p> <p>A measuring instrument shall be designed to reduce as far as possible</p>	See chapter 6	Pass

	the effect of a defect that would lead to an inaccurate measurement result, unless the presence of such a defect is obvious.		
7	Suitability		Pass
7.1	A measuring instrument shall have no feature likely to facilitate fraudulent use, whereas possibilities for unintentional misuse shall be minimal.	See chapter 7	Pass
7.2	A measuring instrument shall be suitable for its intended use taking account of the practical working conditions and shall not require unreasonable demands of the user in order to obtain a correct measurement result.		Pass
7.3	The errors of a utility measuring instrument at flows or currents outside the controlled range shall not be unduly biased.	See Appendix A	Pass
7.4	Where a measuring instrument is designed for the measurement of values of the measurand that are constant over time, the measuring instrument shall be insensitive to small fluctuations of the value of the measurand, or shall take appropriate action.		N.A.
7.5	A measuring instrument shall be robust and its materials of construction shall be suitable for the conditions in which it is intended to be used.		Pass
7.6	A measuring instrument shall be designed so as to allow the control of the measuring tasks after the instrument has been placed on the market and put into use. If necessary, special equipment or software for this control shall be part of the instrument. The test procedure shall be described in the operation manual. When a measuring instrument has associated software which provides other functions besides the measuring function, the software that is critical for the metrological characteristics shall be identifiable and shall not be inadmissibly influenced by the associated software.		Pass
8	Protection against corruption	See chapter 7	Pass
8.1	The metrological characteristics of a measuring instrument shall not be influenced in any inadmissible way by the connection to it of another device, by any feature of the connected device itself or by any remote device that communicates with the measuring instrument.		Pass
8.2	A hardware component that is critical for metrological characteristics shall be designed so that it can be secured. Security measures foreseen shall provide for evidence of an intervention.		Pass
8.3	Software that is critical for metrological characteristics shall be identified as such and shall be secured. Software identification shall be easily provided by the measuring instrument. Evidence of an intervention shall be available for a reasonable period of time.		Pass
8.4	Measurement data, software that is critical for measurement characteristics and metrologically important parameters stored or transmitted shall be adequately protected against accidental or intentional corruption.		Pass
8.5	For utility measuring instruments the display of the total quantity supplied or the displays from which the total quantity supplied can be		Pass

	derived, whole or partial reference to which is the basis for payment, shall not be able to be reset during use.		
9	Information to be borne by and to accompany the instrument		
9.1	A measuring instrument shall bear the following inscriptions: (a) manufacturer's name, registered trade name or registered trade mark; (b) information in respect of its accuracy; and, where applicable: (c) information in respect of the conditions of use; (d) measuring capacity; (e) measuring range; (f) identity marking; (g) number of the EU-type examination certificate or the EU design examination certificate; (h) information whether or not additional devices providing metrological results comply with the provisions of this Directive on legal metrological control.		Pass
9.2	An instrument of dimensions too small or of too sensitive a composition to allow it to bear the relevant information shall have its packaging, if any, and the accompanying documents required by the provisions of this Directive suitably marked.		N.A.
9.3	The instrument shall be accompanied by information on its operation, unless the simplicity of the measuring instrument makes this unnecessary. Information shall be easily understandable and shall include where relevant: (a) rated operating conditions; (b) mechanical and electromagnetic environment classes; (c) the upper and lower temperature limit, whether condensation is possible or not, open or closed location; (d) instructions for installation, maintenance, repairs, permissible adjustments; (e) instructions for correct operation and any special conditions of use; (f) conditions for compatibility with interfaces, sub-assemblies or measuring instruments.		Pass
9.4	Groups of identical measuring instruments used in the same location or used for utility measurements do not necessarily require individual instruction manuals.		N.T.
9.5	Unless specified otherwise in an instrument-specific annex, the scale interval for a measured value shall be in the form 1×10^n , 2×10^n , or 5×10^n , where n is any integer or zero. The unit of measurement or its symbol shall be shown close to the numerical value.		Pass
9.6	A material measure shall be marked with a nominal value or a scale, accompanied by the unit of measurement used.		Pass
9.7	The units of measurement used and their symbols shall be in accordance with the provisions of Union legislation on units of measurement and their symbols.		Pass
9.8	All marks and inscriptions required under any requirement shall be clear, non-erasable, unambiguous and non-transferable.		Pass

10	Indication of result		Pass
10.1	Indication of the result shall be by means of a display or hard copy.		Pass
10.2	The indication of any result shall be clear and unambiguous and accompanied by such marks and inscriptions necessary to inform the user of the significance of the result. Easy reading of the presented result shall be permitted under normal conditions of use. Additional indications may be shown provided they cannot be confused with the metrologically controlled indications.		Pass
10.3	In the case of hard copy the print or record shall also be easily legible and non-erasable.		N.A.
10.4	A measuring instrument for direct sales trading transactions shall be designed to present the measurement result to both parties in the transaction when installed as intended. When critical in case of direct sales, any ticket provided to the consumer by an ancillary device not complying with the appropriate requirements of this Directive shall bear appropriate restrictive information.		N.A.
10.5	Whether or not a measuring instrument intended for utility measurement purposes can be remotely read it shall in any case be fitted with a metrologically controlled display accessible without tools to the consumer. The reading of this display is the measurement result that serves as the basis for the price to pay.		Pass
11	Further processing of data to conclude the trading transaction		Pass
11.1	A measuring instrument other than a utility measuring instrument shall record by a durable means the measurement result accompanied by information to identify the particular transaction, when: (a) the measurement is non-repeatable; and (b) the measuring instrument is normally intended for use in the absence of one of the trading parties.		Pass
11.2	Additionally, a durable proof of the measurement result and the information to identify the transaction shall be available on request at the time the measurement is concluded.		Pass
12	Conformity evaluation		
	A measuring instrument shall be designed so as to allow ready evaluation of its conformity with the appropriate requirements of this Directive.		Pass

Annex II, Module B: EU-Type Examination

1	'EU-type examination' is the part of a conformity assessment procedure in which a notified body examines the technical design of an instrument and verifies and attests that the technical design of the instrument meets the requirements of this Directive that apply to it.	Type exam. Cert.	Pass
2	EU-type examination may be carried out in either of the following manners: (a) examination of a specimen, representative of the production envisaged, of the complete measuring instrument (production type), (b) assessment of the adequacy of the technical design of the instrument through examination of the technical documentation and supporting evidence referred to in point 3, plus examination of	Option (a)	Pass

	specimens, representative of the production envisaged, of one or more critical parts of the instrument (combination of production type and design type); (c) assessment of the adequacy of the technical design of the instrument through examination of the technical documentation and supporting evidence referred to in point 3, without examination of a specimen (design type). The notified body decides on the appropriate manner and the specimens required.		
3	The manufacturer shall lodge an application for EU-type examination with a single notified body of his choice. The application shall include: (a) the name and address of the manufacturer and, if the application is lodged by the authorized representative, his name and address as well; (b) a written declaration that the same application has not been lodged with any other notified body; (c) the technical documentation as described in Article 18. The technical documentation shall make it possible to assess the instrument's conformity with the applicable requirements of this Directive and shall include an adequate analysis and assessment of the risk(s). The technical documentation shall specify the applicable requirements and cover, as far as relevant for the assessment, the design, manufacture and operation of the instrument. The application shall in addition contain, wherever applicable: (d) the specimens, representative of the production envisaged. The notified body may request further specimens if needed for carrying out the test programme; (e) the supporting evidence for the adequacy of the technical design solution. This supporting evidence shall mention any documents that have been used, in particular where the relevant harmonized standards, and/or normative documents have not been applied in full. The supporting evidence shall include, where necessary, the results of tests carried out in accordance with other relevant technical specifications by the appropriate laboratory of the manufacturer, or by another testing laboratory on his behalf and under his responsibility.		Pass
4	The notified body shall: For the instrument:		
4.1	examine the technical documentation and supporting evidence to assess the adequacy of the technical design of the instrument;		Pass
	The notified body shall: For the specimen(s):		
4.2	verify that the specimen(s) have been manufactured in conformity with the technical documentation and identify the elements which have been designed in accordance with the applicable provisions of the relevant harmonised standards and/or normative documents, as well as the elements which have been designed in accordance with other relevant technical specifications;		Pass
4.3	carry out appropriate examinations and tests, or have them carried out, to check whether, where the manufacturer has chosen to apply		Pass

	the solutions in the relevant harmonized standards and normative documents, these have been applied correctly;		
4.4	carry out appropriate examinations and tests, or have them carried out, to check whether, where the solutions in the relevant harmonized standards, and/or normative documents have not been applied, the solutions adopted by the manufacturer applying other relevant technical specifications meet the corresponding essential requirements of this Directive;		Pass
4.5	agree with the manufacturer on the location where the examinations and tests will be carried out.		Pass
	For the other parts of the measuring instrument:		
4.6	examine the technical documentation and supporting evidence to assess the adequacy of the technical design of the other parts of the measuring instrument.		Pass
5	The notified body shall draw up an evaluation report that records the activities undertaken in accordance with point 4 and their outcomes. Without prejudice to its obligations vis-à-vis, the notifying authorities, the notified body shall release the content of that report, in full or in part, only with the agreement of the manufacturer.	This document	Pass
6	<p>Where the type meets the requirements of this Directive, the notified body shall issue an EU-type examination certificate to the manufacturer. That certificate shall contain the name and address of the manufacturer, the conclusions of the examination, the conditions (if any) for its validity and the necessary data for identification of the approved type. The EU-type examination certificate may have one or more annexes attached.</p> <p>The EU-type examination certificate and its annexes shall contain all relevant information to allow the conformity of manufactured measuring instruments with the examined type to be evaluated and to allow for in-service control. In particular, to allow the conformity of manufactured instruments to be evaluated with the examined type regarding the reproducibility of their metrological performances, when they are properly adjusted using appropriate means, content shall include:</p> <ul style="list-style-type: none"> • the metrological characteristics of the type of instrument; • measures required for ensuring the integrity of the instruments (sealing, identification of software, etc.); • information on other elements necessary for the identification of the instruments and to check their visual external conformity to type; • if appropriate, any specific information necessary to verify the characteristics of manufactured instruments; • in the case of a sub-assembly, all necessary information to ensure the compatibility with other sub-assemblies or measuring instruments. <p>The EU-type examination certificate shall have a validity of 10 years from the date of its issue, and may be renewed for subsequent periods of 10 years each.</p> <p>Where the type does not satisfy the applicable requirements of this</p>		Pass

	Directive, the notified body shall refuse to issue an EU-type examination certificate and shall inform the applicant accordingly, giving detailed reasons for its refusal.		
7	The notified body shall keep itself apprised of any changes in the generally acknowledged state of the art which indicate that the approved type may no longer comply with the applicable requirements of this Directive, and shall determine whether such changes require further investigation. If so, the notified body shall inform the manufacturer accordingly.	KEMA Laboratories procedures	Pass
8	The manufacturer shall inform the notified body that holds the technical documentation relating to the EU-type examination certificate of all modifications to the approved type that may affect the conformity of the instrument with the essential requirements of this Directive or the conditions for validity of that certificate. Such modifications shall require additional approval in the form of an addition to the original EU-type examination certificate.	Responsibility of manufacturer	
9	Each notified body shall inform its notifying authority concerning the EU-type examination certificates and/or any additions thereto which it has issued or withdrawn, and shall, periodically or upon request, make available to its notifying authority the list of such certificates and/or any additions thereto refused, suspended or otherwise restricted. The Commission, the Member States and the other notified bodies may, on request, obtain a copy of the EU-type examination certificates and/or additions thereto. On request, the Commission and the Member States may obtain a copy of the technical documentation and the results of the examinations carried out by the notified body. The notified body shall keep a copy of the EU-type examination certificate, its annexes and additions, as well as the technical file including the documentation submitted by the manufacturer until the expiry of the validity of that certificate.	KEMA Laboratories procedures	Pass
10	The manufacturer shall keep a copy of the EU-type examination certificate, its annexes and additions together with the technical documentation at the disposal of the national authorities for 10 years after the instrument has been placed on the market.		Pass

Annex V, Active Electrical Energy Meters (MI-003)

1	Accuracy The manufacturer shall specify the class index of the meter. The class indices are defined as: Class A, B and C.	See chapter 3	Pass
2	Rated operating conditions The manufacturer shall specify the rated operating conditions of the meter; in particular: The values of f_n , U_n , I_n , I_{st} , I_{min} , I_{tr} and I_{max} that apply to the meter. For the current values specified, the meter shall satisfy the conditions given in Table 1 (see MID)	See chapter 3	Pass
	The voltage, frequency and power factor ranges within which the meter shall satisfy the MPE requirements are specified in Table 2.		Pass

	<p>These ranges shall recognize the typical characteristics of electricity supplied by public distribution systems.</p> <p>The voltage and frequency ranges shall be at least:</p> $0,9 \cdot U_n \leq U \leq 1,1 \cdot U_n$ $0,98 \cdot f_n \leq f \leq 1,02 \cdot f_n$ <p>power factor range at least from $\cos\phi = 0,5$ inductive to $\cos\phi = 0,8$ capacitive.</p>		
3	<p>MPEs</p> <p>The effects of the various measurands and influence quantities (a, b, c,...) are evaluated separately, all other measurands and influence quantities being kept relatively constant at their reference values. The error of measurement, that shall not exceed the MPE stated in Table 2, is calculated as: Error of measurement = $\sqrt{(a^2+b^2+c^2 \dots)}$</p> <p>When the meter is operating under varying-load current, the percentage errors shall not exceed the limits given in Table 2.</p> <p>When a meter operates in different temperature ranges the relevant MPE values shall apply.</p> <p>The meter shall not exploit the MPEs or systematically favour any party.</p>	See chapter 5	Pass
4	Permissible effect of disturbances		
4.1	<p>General</p> <p>As electrical energy meters are directly connected to the mains supply and as mains current is also one of the measurands, a special electromagnetic environment is used for electricity meters. EN L 96/210 Official Journal of the European Union 29.3.2014</p> <p>The meter shall comply with the electromagnetic environment E2 and the additional requirements in points 4.2 and 4.3.</p> <p>The electromagnetic environment and permissible effects reflect the situation that there are disturbances of long duration which shall not affect the accuracy beyond the critical change values and transient disturbances, which may cause a temporary degradation or loss of function or performance but from which the meter shall recover and shall not affect the accuracy beyond the critical change values.</p> <p>When there is a foreseeable high risk due to lightning or where overhead supply networks are predominant, the metrological characteristics of the meter shall be protected.</p>	See chapter 4	Pass
4.2	<p>Effect of disturbances of long duration</p> <ul style="list-style-type: none"> Reversed phase sequence Voltage unbalance (only applicable to polyphase meters) Harmonic contents in the current circuits DC and harmonics in the current circuit Fast transient bursts Magnetic fields; HF (radiated RF) electromagnetic field; <p>Conducted disturbances introduced by radio-frequency fields; and Oscillatory waves immunity</p>	See chapter 4	Pass
4.3	Permissible effect of transient electromagnetic phenomena		
4.3.1	The effect of an electromagnetic disturbance on an electrical	See	Pass

	<p>energy meter shall be such that during and immediately after a disturbance:</p> <ul style="list-style-type: none"> any output intended for testing the accuracy of the meter does not produce pulses or signals corresponding to an energy of more than the critical change value, and in reasonable time after the disturbance the meter shall: recover to operate within the MPE limits, and have all measurement functions safeguarded, and allow recovery of all measurement data present prior to the disturbance, and not indicate a change in the registered energy of more than the critical change value. <p>The critical change value in kWh is $m \cdot U_n \cdot I_{max} \cdot 10^{-6}$ (m being the number of measuring elements of the meter, U_n in Volts and I_{max} in Amps).</p>	chapter 4	
4.3.2	For overcurrent the critical change value is 1,5 %.	See § 4.5	Pass
5	Suitability		
5.1	Below the rated operating voltage the positive error of the meter shall not exceed 10 %.		Pass
5.2	The display of the total energy shall have a sufficient number of digits to ensure that when the meter is operated for 4 000 hours at full load ($I = I_{max}$, $U = U_n$ and $PF = 1$) the indication does not return to its initial value and shall not be able to be reset during use.		Pass
5.3	In the event of loss of electricity in the circuit, the amounts of electrical energy measured shall remain available for reading during a period of at least 4 months.		Pass
5.4	Running with no load When the voltage is applied with no current flowing in the current circuit (current circuit shall be open circuit), the meter shall not register energy at any voltage between $0,8 \cdot U_n$ and $1,1 U_n$.	See § 4.3.4	Pass
5.5	Starting The meter shall start and continue to register at U_n , $PF = 1$ (polyphase meter with balanced loads) and a current which is equal to I_{st} .	See § 4.3.3	Pass
6	Units The electrical energy measured shall be displayed in kilowatt-hours or in megawatt-hours.	See § 4.1.9	Pass

Appendix F Measurement uncertainty

The measurement uncertainties in the results presented are as specified below unless otherwise indicated.

EMC Emission

Measurement	Measurement uncertainty	
	U_{lab}	U_{CISPR}
Conducted emission (CISPR 32)		
Mains port	2,84 dB	3,4 dB
TP communication ports	4,62 dB	5,0 dB